

# Bayonet resistance thermometer

## Model TR53

WIKA data sheet TE 60.53



for further approvals  
see page 2

### Applications

- Plastics processing machinery
- Injection moulding machinery
- Cylinder heads and oil sumps in engines
- Bearings
- Pipelines and vessels

### Special features

- Sensor ranges up to max. 400 °C (752 °F)
- Single and dual resistance thermometers
- Good heat transfer through adjustable spring-loading
- Easy installation and removal, no tools needed
- Explosion-protected versions



Model TR53 with optional threaded nipple

## Description

### Probe

This cable resistance thermometer features a bayonet-type probe connection.

TR53 series resistance thermometers can be mounted into drilled holes without thermowells, e.g. into machine components.

### Cable

There are various insulating materials available to match different environmental conditions.

The free ends of the cable are made up ready for connection, or can be fitted with connectors or sockets as optional extras.

## Explosion protection (option)

The permissible power,  $P_{max}$ , as well as the permissible ambient temperature, for the respective category can be seen on the EC-type examination certificate, the certificate for hazardous areas or in the operating instructions.





The internal inductance ( $L_i = 1 \mu\text{H/m}$ ) and capacitance ( $C_i = 200 \text{ pF/m}$ ) for cable probes are found on the product label and they should be taken into account when connecting to an intrinsically safe power supply.











### Note:

When mounting thermometers with flying leads, installation personnel must ensure that installation is carried out properly and in compliance with the appropriate regulations. If the cable ends of the thermometer are within the hazardous area, suitable adapters/connectors must be used. Flying leads must be connected outside the hazardous area or, when operated in a dust explosive atmosphere, within an enclosure which is certified.

The connection of a resistance thermometer (e.g. Pt100) to a transmitter must be made with shielded cable. The shield must be electrically connected to the case of the grounded thermometer. It should be ensured that there is equipotential bonding on installation, so that no balancing current can flow via the shield. Here, in particular, the installation regulations for hazardous areas should be followed!

## Approvals (explosion protection, further approvals)

Logo	Description	Country																								
 	<p><b>EU declaration of conformity</b></p> <ul style="list-style-type: none"> <li>■ RoHS directive</li> <li>■ ATEX directive (option)</li> </ul> <p>Hazardous areas</p> <table border="0"> <tr> <td>- Ex i</td> <td>Zone 0 gas</td> <td>[II 1G Ex ia IIC T1 ... T6 Ga]</td> </tr> <tr> <td></td> <td>Zone 1 mounting to zone 0 gas</td> <td>[II 1/2G Ex ia IIC T1 ... T6 Ga/Gb]</td> </tr> <tr> <td></td> <td>Zone 1 gas</td> <td>[II 2G Ex ia IIC T1 ... T6 Gb]</td> </tr> <tr> <td></td> <td>Zone 20 dust</td> <td>[II 1D Ex ia IIIC T125 ... T65 °C Da]</td> </tr> <tr> <td></td> <td>Zone 21 mounting to zone 20 dust</td> <td>[II 1/2D Ex ia IIIC T125 ... T65 °C Da/Db]</td> </tr> <tr> <td></td> <td>Zone 21 dust</td> <td>[II 2D Ex ia IIIC T125 ... T65 °C Db]</td> </tr> <tr> <td>- Ex n</td> <td>Zone 2 gas</td> <td>[II 3G Ex nA IIC T1 ... T6 Gc X]</td> </tr> <tr> <td></td> <td>Zone 22 dust</td> <td>[II 3D Ex tc IIIC T440 ... T80 °C Dc X]</td> </tr> </table>	- Ex i	Zone 0 gas	[II 1G Ex ia IIC T1 ... T6 Ga]		Zone 1 mounting to zone 0 gas	[II 1/2G Ex ia IIC T1 ... T6 Ga/Gb]		Zone 1 gas	[II 2G Ex ia IIC T1 ... T6 Gb]		Zone 20 dust	[II 1D Ex ia IIIC T125 ... T65 °C Da]		Zone 21 mounting to zone 20 dust	[II 1/2D Ex ia IIIC T125 ... T65 °C Da/Db]		Zone 21 dust	[II 2D Ex ia IIIC T125 ... T65 °C Db]	- Ex n	Zone 2 gas	[II 3G Ex nA IIC T1 ... T6 Gc X]		Zone 22 dust	[II 3D Ex tc IIIC T440 ... T80 °C Dc X]	European Union
- Ex i	Zone 0 gas	[II 1G Ex ia IIC T1 ... T6 Ga]																								
	Zone 1 mounting to zone 0 gas	[II 1/2G Ex ia IIC T1 ... T6 Ga/Gb]																								
	Zone 1 gas	[II 2G Ex ia IIC T1 ... T6 Gb]																								
	Zone 20 dust	[II 1D Ex ia IIIC T125 ... T65 °C Da]																								
	Zone 21 mounting to zone 20 dust	[II 1/2D Ex ia IIIC T125 ... T65 °C Da/Db]																								
	Zone 21 dust	[II 2D Ex ia IIIC T125 ... T65 °C Db]																								
- Ex n	Zone 2 gas	[II 3G Ex nA IIC T1 ... T6 Gc X]																								
	Zone 22 dust	[II 3D Ex tc IIIC T440 ... T80 °C Dc X]																								
 	<p><b>IECEx (option)</b> (in conjunction with ATEX)</p> <p>Hazardous areas</p> <table border="0"> <tr> <td>- Ex i</td> <td>Zone 0 gas</td> <td>[Ex ia IIC T1 ... T6 Ga]</td> </tr> <tr> <td></td> <td>Zone 1 mounting to zone 0 gas</td> <td>[Ex ia IIC T1 ... T6 Ga/Gb]</td> </tr> <tr> <td></td> <td>Zone 1 gas</td> <td>[Ex ia IIC T1 ... T6 Gb]</td> </tr> <tr> <td></td> <td>Zone 20 dust</td> <td>[Ex ia IIIC T125 ... T65 °C Da]</td> </tr> <tr> <td></td> <td>Zone 21 mounting to zone 20 dust</td> <td>[Ex ia IIIC T125 ... T65 °C Da/Db]</td> </tr> <tr> <td></td> <td>Zone 21 dust</td> <td>[Ex ia IIIC T125 ... T65 °C Db]</td> </tr> </table>	- Ex i	Zone 0 gas	[Ex ia IIC T1 ... T6 Ga]		Zone 1 mounting to zone 0 gas	[Ex ia IIC T1 ... T6 Ga/Gb]		Zone 1 gas	[Ex ia IIC T1 ... T6 Gb]		Zone 20 dust	[Ex ia IIIC T125 ... T65 °C Da]		Zone 21 mounting to zone 20 dust	[Ex ia IIIC T125 ... T65 °C Da/Db]		Zone 21 dust	[Ex ia IIIC T125 ... T65 °C Db]	International						
- Ex i	Zone 0 gas	[Ex ia IIC T1 ... T6 Ga]																								
	Zone 1 mounting to zone 0 gas	[Ex ia IIC T1 ... T6 Ga/Gb]																								
	Zone 1 gas	[Ex ia IIC T1 ... T6 Gb]																								
	Zone 20 dust	[Ex ia IIIC T125 ... T65 °C Da]																								
	Zone 21 mounting to zone 20 dust	[Ex ia IIIC T125 ... T65 °C Da/Db]																								
	Zone 21 dust	[Ex ia IIIC T125 ... T65 °C Db]																								

Logo	Description	Country
	<b>EAC (option)</b> Hazardous areas - Ex i Zone 0 gas [0 Ex ia IIC T3/T4/T5/T6] Zone 1 gas [1 Ex ib IIC T3/T4/T5/T6] Zone 20 dust [DIP A20 Ta 65 °C/Ta 95 °C/Ta 125 °C] Zone 21 dust [DIP A21 Ta 65 °C/Ta 95 °C/Ta 125 °C] - Ex n Zone 2 gas [Ex nA IIC T6 ... T1] Zone 22 dust [DIP A22 Ta 80 ... 440 °C]	Eurasian Economic Community
	<b>INMETRO (option)</b> Hazardous areas - Ex i Zone 0 gas [Ex ia IIC T3 ... T6 Ga] Zone 1 mounting to zone 0 gas [Ex ib IIC T3 ... T6 Ga/Gb] Zone 1 gas [Ex ib IIC T3 ... T6 Gb] Zone 20 dust [Ex ia IIIC T125 ... T65 °C Da] Zone 21 mounting to zone 20 dust [Ex ib IIIC T125 ... T65 °C Da/Db] Zone 21 dust [Ex ib IIIC T125 ... T65 °C Db]	Brazil
	<b>NEPSI (option)</b> Hazardous areas - Ex i Zone 0 gas [Ex ia IIC T3 ~ T6] Zone 1 mounting to zone 0 gas [Ex ia/ib IIC T3 ~ T6] Zone 1 gas [Ex ib IIC T3 ~ T6]	China
	<b>KCs - KOSHA (option)</b> Hazardous areas - Ex i Zone 0 gas [Ex ia IIC T4 ... T6] Zone 1 gas [Ex ib IIC T4 ... T6]	South Korea
-	<b>PESO (option)</b> Hazardous areas - Ex i Zone 0 gas [Ex ia IIC T1 ... T6 Ga] Zone 1 mounting to zone 0 gas [Ex ib IIC T3 ... T6 Ga/Gb] Zone 1 gas [Ex ib IIC T3 ... T6 Gb]	India
	<b>DNOP - MakNII (option)</b> Hazardous areas - Ex i Zone 0 gas [II 1G Ex ia IIC T3, T4, T5, T6 Ga] Zone 1 gas [II 2G Ex ia IIC T3, T4, T5, T6 Gb] Zone 20 dust [II 1D Ex ia IIIC T65, T95, T125 °C Da] Zone 21 dust [II 2D Ex ib IIIC T125 ... T65 °C Db]	Ukraine
	<b>GOST (option)</b> Metrology, measurement technology	Russia
	<b>KazInMetr (option)</b> Metrology, measurement technology	Kazakhstan
-	<b>MTSCHS (option)</b> Permission for commissioning	Kazakhstan
	<b>BelGIM (option)</b> Metrology, measurement technology	Belarus
	<b>UkrSEPRO (option)</b> Metrology, measurement technology	Ukraine
	<b>Uzstandard (option)</b> Metrology, measurement technology	Uzbekistan

Instruments marked with "ia" may also be used in areas only requiring instruments marked with "ib" or "ic".  
 If an instrument with "ia" marking has been used in an area with requirements in accordance with "ib" or "ic", it can no longer be operated in areas with requirements in accordance with "ia" afterwards.

Approvals and certificates, see website

## Sensor

### Application range

The application range of the sensor is limited by the permissible temperature for the cable insulation.

### Sensor connection method

- 2-wire
- 3-wire
- 4-wire

### Sensor tolerance value per IEC 60751

- Class B
- Class A
- Class AA

The combinations of a 2-wire connection with class A or class AA are not permissible, since the lead resistance of the measuring insert negates the higher sensor accuracy.

For detailed specifications for Pt100 sensors, see Technical information IN 00.17 at [www.wika.com](http://www.wika.com).

## Probe

Design: Rigid tube  
Material: Stainless steel  
Diameter: 6 mm or 8 mm  
Length: 10 mm  
other versions on request

For temperature measurement in a solid body, the diameter of the bore into which the sensor should be inserted must be no more than 1 mm larger than the sensor diameter.

## Maximum working temperatures

The maximum working temperature for these thermometers is limited by different parameters.

If the temperature to be measured inside the sensor measuring range is higher than the permissible temperature at the connection cable, the connector or the transition point, the metallic part of the sensor (mineral-insulated cable) must be long enough to place the critical components outside of the hot zone. The lowest of the maximum working temperatures of connection line, cable transition or connector must be observed here.

### ■ Sensor

#### Measuring element

Pt100 (measuring current: 0.1 ... 1.0 mA) <sup>1)</sup>

Connection method	
Single elements	1 x 2-wire 1 x 3-wire 1 x 4-wire
Dual elements	2 x 2-wire 2 x 3-wire 2 x 4-wire <sup>2)</sup>

Tolerance value of the measuring insert per IEC 60751		
Class	Sensor construction	
	Wire-wound	Thin-film
Class B	-196 ... +600 °C	-50 ... +500 °C
	-196 ... +450 °C	-50 ... +250 °C
Class A <sup>3)</sup>	-100 ... +450 °C	-30 ... +300 °C
Class AA <sup>3)</sup>	-50 ... +250 °C	0 ... 150 °C

<sup>1)</sup> For detailed specifications for Pt100 sensors, see Technical information IN 00.17 at [www.wika.com](http://www.wika.com).

<sup>2)</sup> Not with 3 mm diameter

<sup>3)</sup> Not for 2-wire connection method

### ■ Connection cable and single wires

At any point on the connection cable, the maximum temperature that may be attained is that for which the connection cable is specified. The sensor itself can potentially withstand higher temperatures.

For the common connection lines the following maximum operating temperatures apply:

PVC -20 ... +100 °C  
Silicone -50 ... +200 °C  
PTFE -50 ... +250 °C  
Fibreglass -50 ... +400 °C

Since, in the tubular design variant, an isolated cable is also fitted within the metal probe, the operating limits of the connecting cable apply.

### ■ Transition from the metal part of the thermometer to the connection cable

The temperature at the transition is further limited by the use of a potted sealing compound.

Temperature range of the potting compound: -40 ... +150 °C

Option: 250 °C

(other variants on request)

Temperature range of the special low-temperature version:

-60 ... +120 °C <sup>4)</sup>

4) only available with selected approvals

### ■ Connector (option)

With the option of a coupler connector fitted the maximum permissible temperature range is:

Lemos: -55 ... +250 °C

Binder, Amphenol: -40 ... +85 °C

## IP ingress protection

Bayonet resistance thermometers can be delivered with up to IP65 (dependent on cable sheath material and number of wires).

With a special design, IP67 is also possible on request.

Connection leads with a glass-fibre sheath cannot be combined with an explosion-proof version.

## Transition

The junction between the metal part of the probe and the connecting cable or wire is either rolled or potted, depending on the design. This area should not be immersed within the process and must not be bent. Compression fittings should not be attached to the transition. The version and dimensions of the transition depend largely on the combination between supply line and metal sensor and the sealing requirements.

The dimension T describes the length of the transition.

Criterion	Dimensions T in mm	Ø transition in mm
Probe Ø = transition sleeve Ø	n/a	Identical to probe
Ø 6 mm with crimped transition	45	7
Ø 6 mm with crimped transition <sup>5)</sup>	45	8
Ø 8 mm with crimped transition	45	10

5) With a large number of wires (e. g. 2 x 3-wire and shielding)

## Cable

Wire material: Cu (stranded wire)  
 Wire cross-section: approx. 0.22 mm<sup>2</sup>  
 Number of wires: According to the number of sensors and the sensor connection method  
 Wire ends: Blank

### Connecting cable

There are various insulating materials available to match different environmental conditions. The free ends of the cable are made up ready for connection, or can be fitted with connectors or sockets as optional extras.

Probe diameter d in mm	Cable sheath (insulation) silicone		Cable sheath (insulation) PTFE		
	Working temperature -50 ... +200 °C		Working temperature -50 ... +250 °C		
	Standard	Shielded	Standard	Shielded	With stainless steel braiding
6	1 x 2-wire	-	1 x 2-wire	1 x 2-wire	1 x 2-wire
	1 x 2-wire	-	1 x 3-wire	1 x 3-wire	1 x 3-wire
	1 x 2-wire	-	1 x 4-wire	1 x 4-wire	1 x 4-wire
	1 x 2-wire	-	2 x 2-wire	2 x 2-wire	2 x 2-wire
8	1 x 2-wire	1 x 2-wire	1 x 2-wire	1 x 2-wire	1 x 2-wire
	1 x 3-wire	1 x 3-wire	1 x 3-wire	1 x 3-wire	1 x 3-wire
	1 x 4-wire	1 x 4-wire	1 x 4-wire	1 x 4-wire	1 x 4-wire
	2 x 2-wire	2 x 2-wire	2 x 2-wire	2 x 2-wire	2 x 2-wire
	2 x 3-wire	-	-	2 x 3-wire	2 x 3-wire

## Process connection

Bayonet cap on the probe, with matching threaded nipple for screw-fitting to a solid body (process).

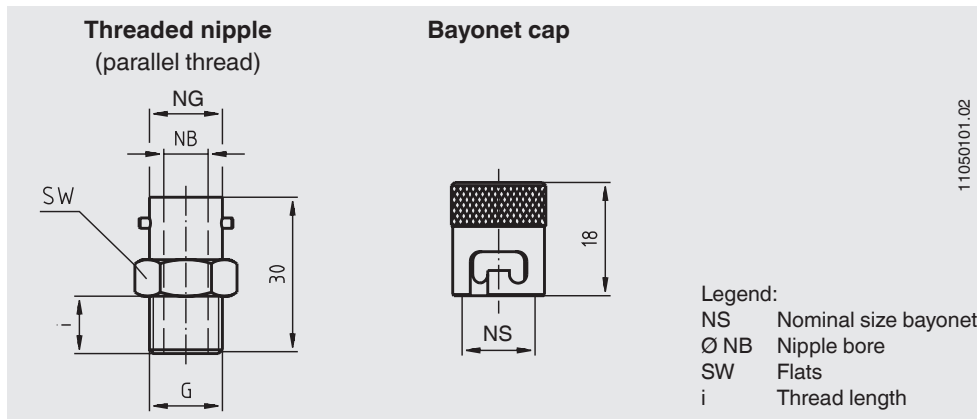

Probe Ø Ø d	Process connection	NS	Nipple bore	Spring Ø Ø FD	Flats SW	Thread length i	Order no.
			Ø NB				
6	M10 x 1	12	6,4	6	14	10	3120914
	M14 x 1,5	14	8,4	6	17	10	3366788
	G ¼ B	14	8,4	6	17	10	3118927
	G ⅜ B	14	8,4	6	17	11	3118901
8	M14 x 1,5	14	8,4	7	17	10	3366788
	G ¼ B	14	8,4	7	17	10	3118927
	G ⅜ B	14	8,4	7	17	11	3118901

Material: Brass, nickel-plated

# Dimensions in mm

## Bayonet cap fixed to the end of the spring (sheathed cable design)

Probe tip, flat

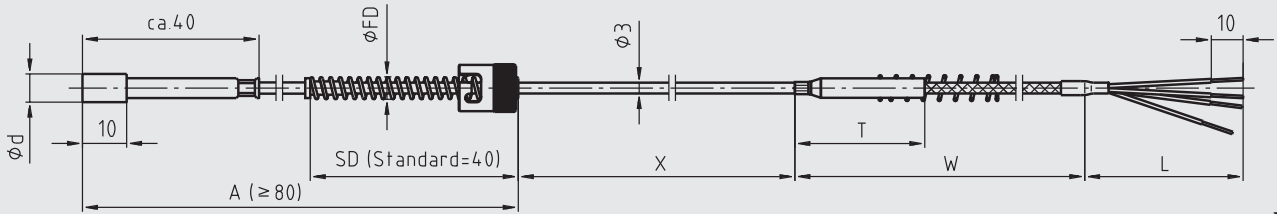

Probe tip, chamfered

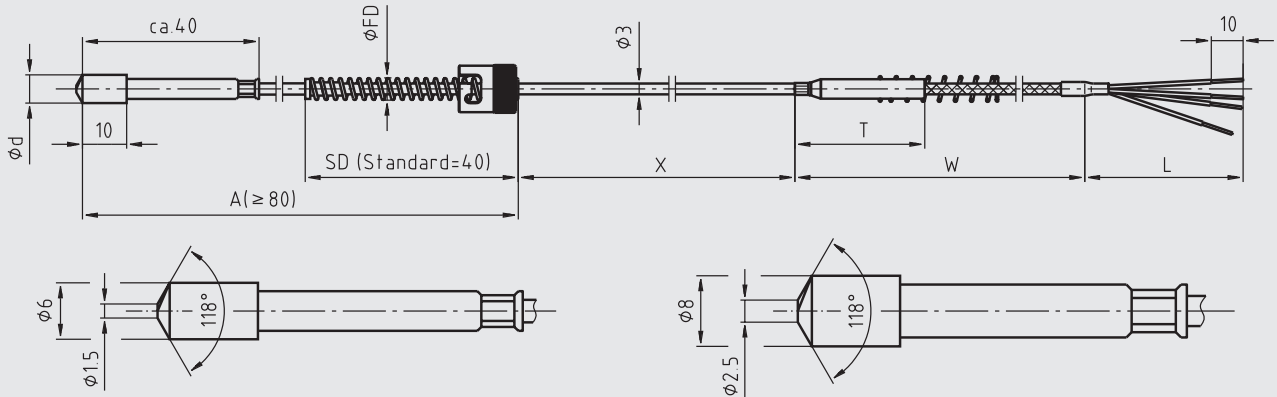

Probe tip, round

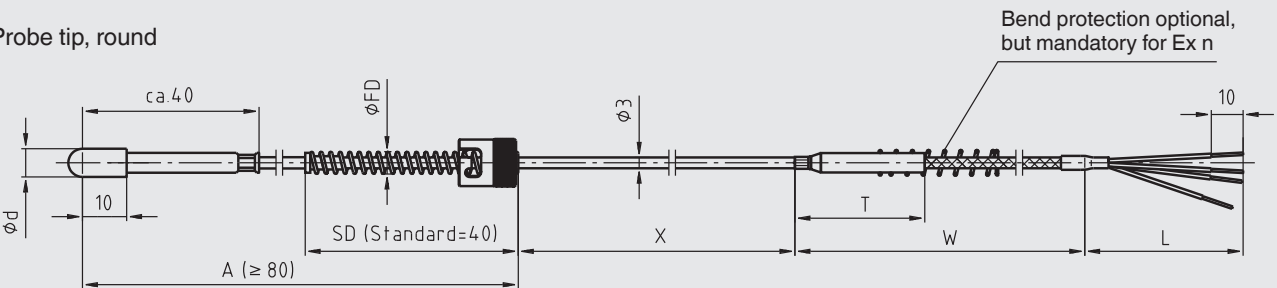

Legend:

- Ø d Probe diameter
- L Probe length
- W Cable length
- Ø FD Spring diameter
- A Insertion length
- X Probe extension
- T Transition sleeve
- SD Spring length

11344148.01

## Bayonet cap adjustable on the spring (sheathed cable design)

Probe tip, flat

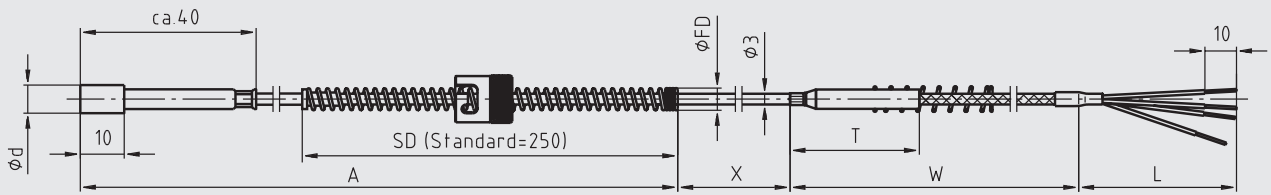

Probe tip, chamfered

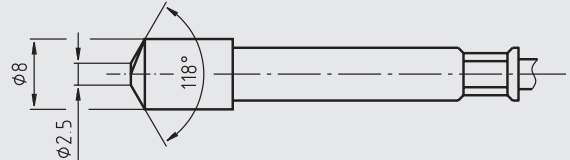
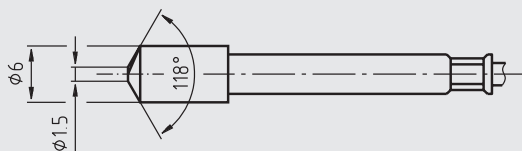
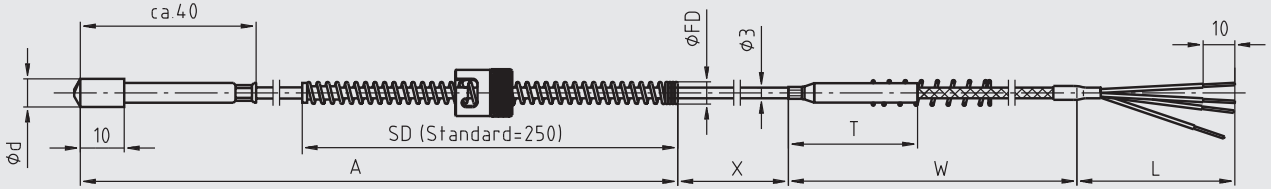

Probe tip, round

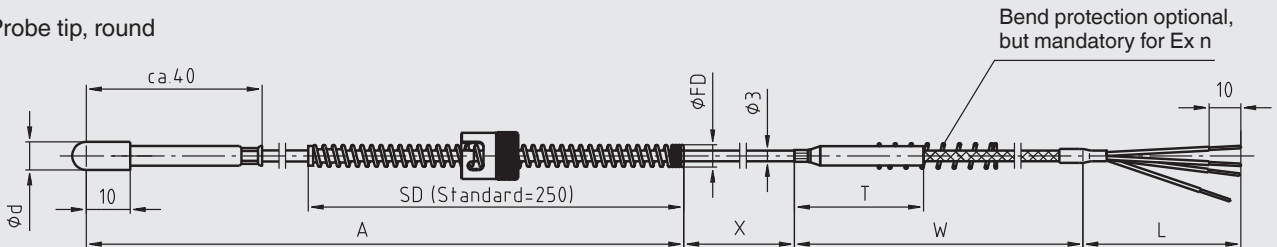

**Legend:**

- $\phi d$  Probe diameter
- L Probe length
- W Cable length
- $\phi FD$  Spring diameter
- A Insertion length
- X Probe extension
- T Transition sleeve
- SD Spring length

11343168.02



## Bayonet cap adjustable on the spring (cable through to the probe tip)

Probe tip, flat

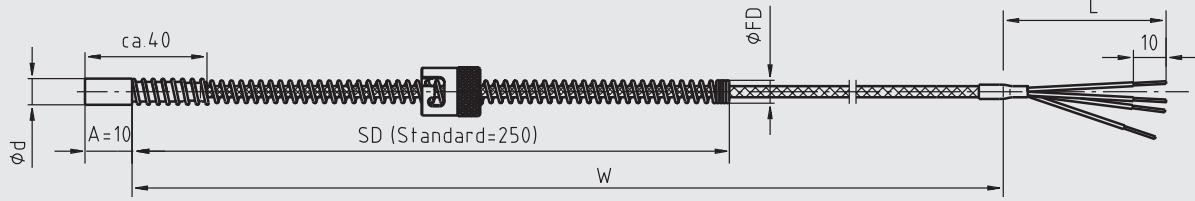

Probe tip, chamfered

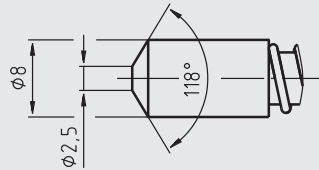
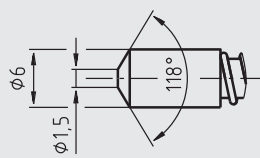
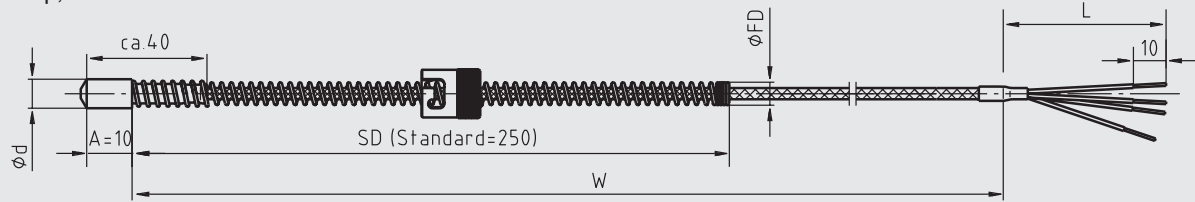

Probe tip, round

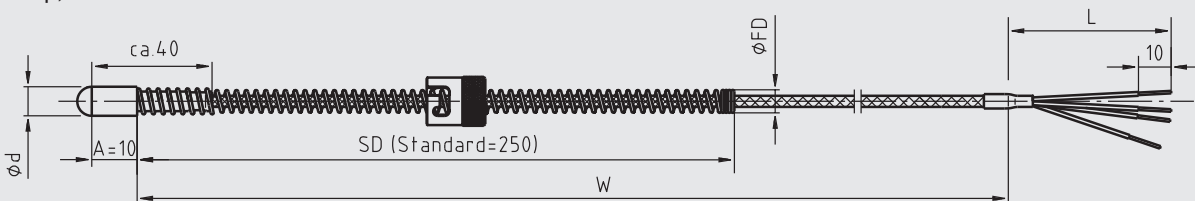

11050101.02

### Legend:

- Ø d Probe diameter
- L Probe length
- W Cable length
- Ø FD Spring diameter
- A Insertion length
- X Probe extension
- T Transition sleeve
- SD Spring length

## Connector (option)

Bayonet resistance thermometers can be supplied with connectors fitted.  
The following options are available:

- **Screw-in-connector, Binder (male)**

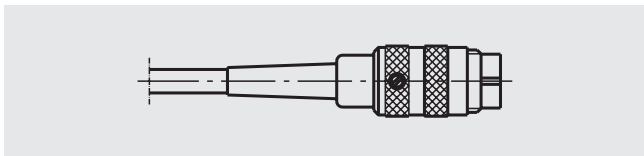

- **Screw-in-connector, Binder (female)**

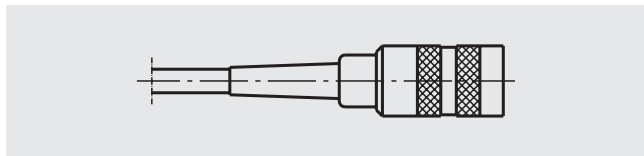

- **Lemosa connector size 1 S (male)**
- **Lemosa connector size 2 S (male)**

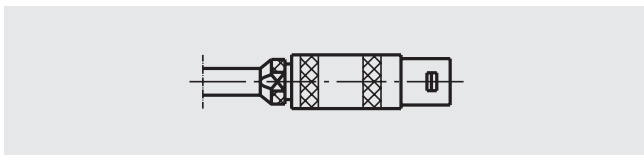

- **Lemosa coupling size 1 S (female)**
- **Lemosa coupling size 2 S (female)**

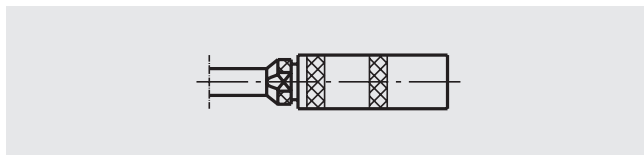

- **Spade lugs**

(not suitable for versions with bare connecting wires)

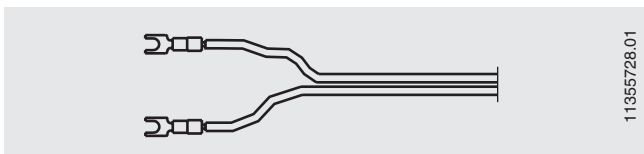

Other connector variants (sizes) on request.

# Electrical connection

## Without connector

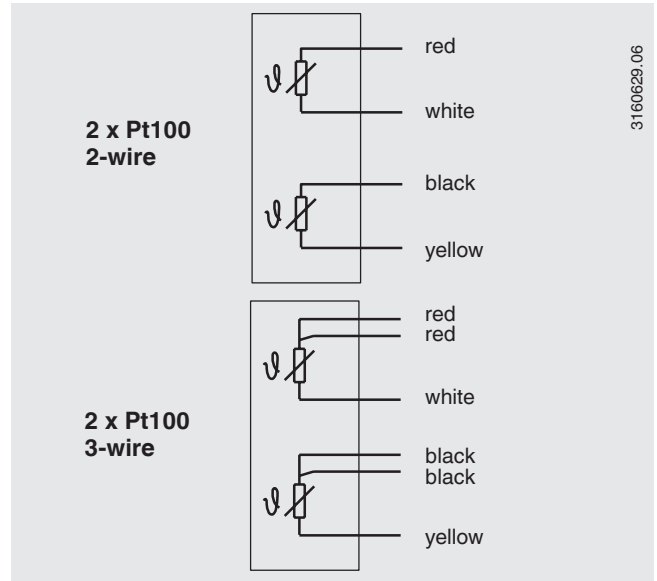
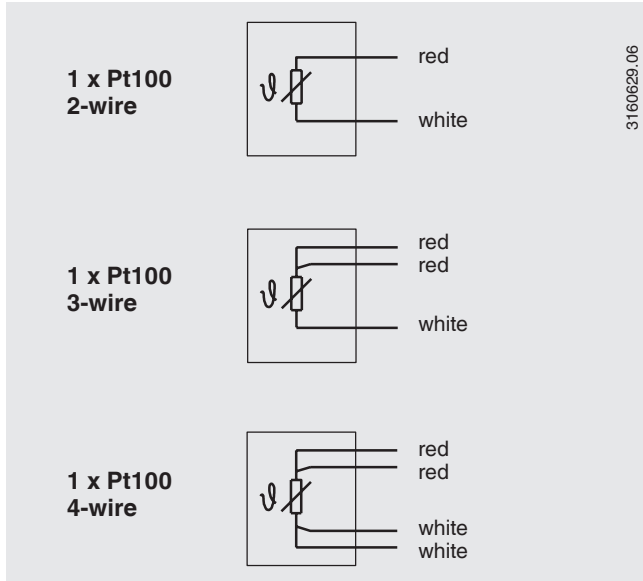

## Lemosa connector

max. permissible temperature range: -55 ... +250 °C

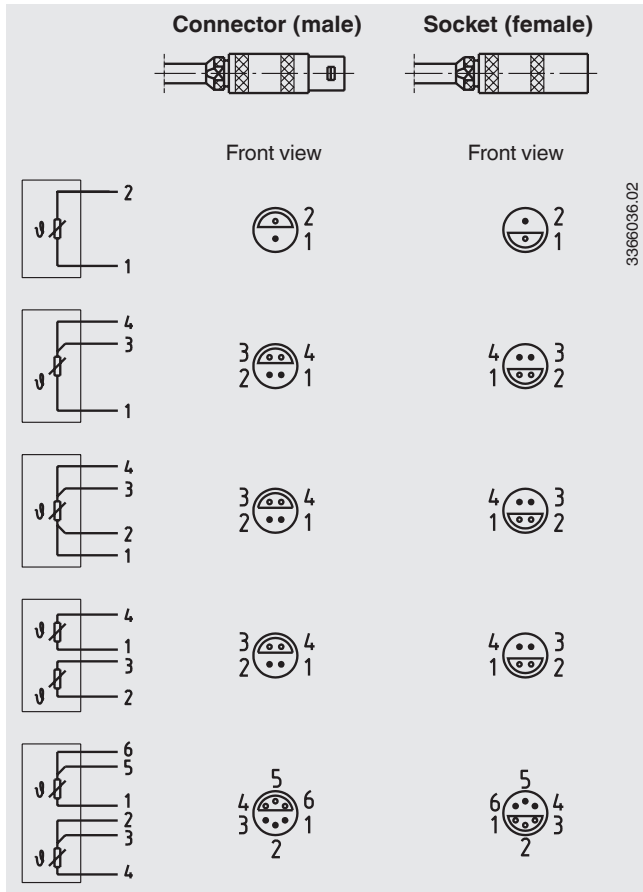

## Screw-in-connector, (Amphenol, Binder)

max. permissible temperature range: -40 ... +85 °C

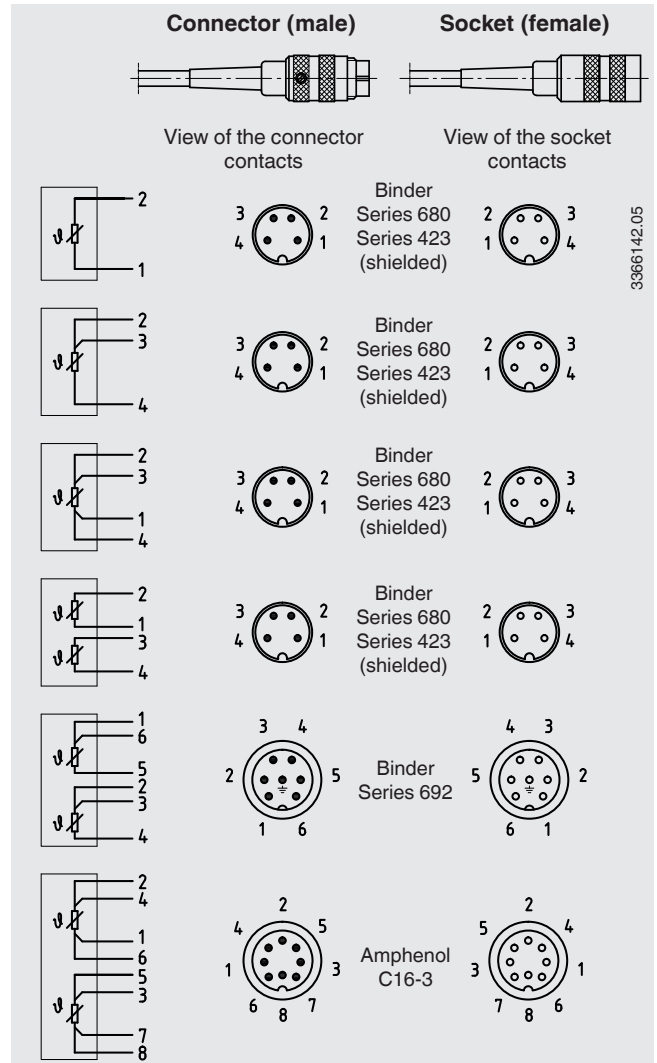

## Certificates (option)

Certification type	Measuring accuracy	Material certificate
2.2 Test report	x	x

Other certificates on request.

### Ordering information

Model / Bayonet version / Explosion protection / Sensor tip version / Probe diameter and length / Probe version / Bayonet cap material / Measuring element / Temperature range / Sheath, raw material / Connection cable, sheath / Lead end version / Certificates / Options

© 12/2010 WIKA Alexander Wiegand SE & Co. KG, all rights reserved.  
The specifications given in this document represent the state of engineering at the time of publishing.  
We reserve the right to make modifications to the specifications and materials.

