

High-End Pressure Controller

CPC8000





Warning

This Warning symbol indicates that danger of injury for persons and the environment and/or considerable material damage (mortal danger, danger of injury) will occur if the respective safety precautions are not taken.



Caution

This Caution symbol indicates danger for the system and material if the respective safety precautions are not taken.



Notice

This Notice symbol does not indicate safety notices but information for a better understanding of the facts

Table of Contents

1. General Information	7
1.1 Warranty	7
1.2 Important Notice	7
1.3 FCC Radio Frequency Emission Notice	7
1.4 Trademarks and Copyrights (C)	8
1.5 Software License Agreement	8
1.6 Mensor Service Plus	8
1.6.1 After the Warranty	8
1.6.2 Calibration Services	8
1.6.3 Accreditations	9
1.7 Packaging for Shipment	9
2. Safety Notices	10
2.1 User Responsibilities	10
2.2 General Safety Notices	10
2.3 Warnings and Caution Notices	11
3. Product Description	12
3.1 General Description	12
3.1.1 IntelliScale Transducer Choices	12
3.2 Front Panel	13
3.2.1 Power Switch	13
3.2.2 USB Port	13
3.2.3 Information Label	13
3.2.4 Screen	13
3.2.4.1 Main Screen Features	14
3.2.4.2 Screen Navigation	14
3.3 Main Features	15
4. Specifications	16
4.1 Measure Specifications	16
4.2 Control Specifications	17
4.3 General Specifications	17
4.4 Transducer Removal/Replacement	19
4.5 Regulator Ranges	20
4.6 Transducer Choices	21
4.6.1 Transducer Type / Range / Mode / Accuracy	22
4.7 IntelliScale	23
4.7.1 Optional IntelliScale	23
5. Installation	24
5.1 Initial Installation	24
5.2 Unpacking the system	24
5.3 Dimensions	25
5.4 Turning on the CPC8000	26
5.5 Pressure Connections	26
5.5.1 Supply	27
5.5.2 Exhaust	27
5.5.3 Vent	27
5.5.4 Reference	27
5.5.4.1 Measure/Control	27
5.5.4.2 Barometric Reference	27
5.6 Pneumatic Connections and Pressure Fittings	28
5.7 Electrical & Communication Connections	29

5.7.1	Notices Regarding the Electrical Connections	30
5.7.1.1	Power Supply	30
5.7.1.2	Interfaces	30
5.7.1.3	Ethernet Interface	30
5.7.1.4	USB Host Interface	30
5.7.1.5	USB Device Interface.	30
5.7.1.6	RS-232 Interface	30
5.7.1.7	IEEE-488 Interface	30
5.7.1.8	Input/Output Port	31
6.	Local Operation	32
6.1	General	32
6.1.1	Buttons, Keys, Switches, Tabs, and other terms	33
6.1.2	Map of the Main Screen Features	33
6.2	Main Screen Features	34
6.2.1	Autorange / Range Hold	34
6.2.2	Pressure Reading	35
6.2.3	Setpoint Button	35
6.2.4	Setpoint Value.	35
6.2.5	Setup.	36
6.2.6	Setpoint Entry Methods	36
6.2.6.1	Number Key Pad	37
6.2.6.2	Number Pad / Step	37
6.2.6.3	Percentage Step	38
6.2.6.4	Digital Step	39
6.2.6.5	Program Data Entry	40
6.2.7	Favorites	41
6.2.8	Status Bar	41
6.2.9	Secondary and Tertiary Display	42
6.2.10	Limits.	43
6.2.11	Bar Graph	43
6.2.12	Pressure Units	44
6.2.13	Pressure Type	44
6.2.14	Zero/Tare Button	45
6.2.15	Operating Modes.	47
6.2.15.1	Measure Mode	48
6.2.15.2	Control Mode	50
6.2.15.3	Vent Mode	52
6.2.15.4	State of the Isolation Valves when the CPC8000 is off.	53
7.	Setup	54
7.1	General Tab	56
7.1.1	Language	56
7.1.2	Secondary and Tertiary Display	56
7.1.3	Calibration Function.	57
7.1.4	Brightness	58
7.1.5	Volume	58
7.1.6	Barometer (Units)	59
7.1.7	Load (Configuration)	60
7.1.8	Save (Configuration)	61
7.2	Sensor Tab	62
7.2.1	Sensor Filter	62
7.2.2	Resolution (Display Digits)	63

7.2.3	Units	63
7.2.4	Rate Units	64
7.2.5	User Units	64
7.3	Control Tab	65
7.3.1	Max and Minimum Limits	65
7.3.2	Stable Limits	66
7.3.3	Rate Setpoint	67
7.3.4	Vent Rate	67
7.3.5	Vent Limit	68
7.4	Remote Tab	69
7.4.1	Remote Command Set Setup	69
7.4.2	IEEE-488 Address	70
7.4.3	Ethernet Settings.	70
7.4.4	Serial Settings.	71
7.4.5	USB Device Setting	71
7.5	Applications Tab	72
7.5.1	Passwords	72
7.5.2	Calibration of Internal Transducers	73
7.5.2.1	Calibration Environment	74
7.5.2.2	Calibration Pressure Standards	74
7.5.2.3	Calibration Media	74
7.5.2.4	Calibration Setup	74
7.5.2.5	Calibration Adjustment Procedure	76
7.5.3	Programs	82
7.5.4	Favorites	84
7.5.5	Digital I/O	84
7.5.6	Troubleshoot	86
7.5.7	Adaptation	86
7.6	Service Menu	90
7.6.1	Tune	90
7.6.2	Admin	92
7.6.2.1	Change Password	92
7.6.3	Software Upgrade	93
7.7	Info Tab	94
8.	Remote Operation	95
8.1	Software/Functions	95
8.2	Remote Command Set.	95
8.3	SCPI WIKA Command Set	106
8.4	SCPI Error Messages and Error Codes	110
8.5	Command Emulation	111
8.5.1	PCS 400 Emulated Commands	111
9.	Options	113
9.1	Transport Case	113
9.2	Rack Mount Kit	113
9.3	Barometric Reference Transducer	113
9.4	Model 75 Pressure Booster System	114
10.	Maintenance	115
10.1	Beyond the Warranty	115
10.2	Troubleshooting	115
10.2.1	Pressure Transducer Location	117
10.2.2	Transducer Removal / Replacement	117

10.2.3 Side Panel Removal	118
11. Appendix	119
11.1 Measurement Units	119
11.2 Conversion Factors, bar	120
11.3 Conversion Factors, PSI	121
11.4 Conversion Factors, millitorr	122

1 General Information

1.1 Warranty

All products manufactured by Mensor are warranted to be free of defects in workmanship and materials for a period of two years from the date of shipment. No other express warranty is given, and no affirmation of Seller, by words or actions, shall constitute a warranty. SELLER DISCLAIMS ANY IMPLIED WARRANTIES OF MERCHANTABILITY OR FITNESS FOR ANY PARTICULAR PURPOSES WHATSOEVER. If any defect in workmanship or material should develop under conditions of normal use and service within the warranty period, repairs will be made at no charge to the original purchaser, upon delivery of the product(s) to the factory, shipping charges prepaid. If inspection by Mensor or its authorized representative reveals that the product was damaged by accident, alteration, misuse, abuse, faulty installation or other causes beyond the control of Mensor, this warranty does not apply. The judgment of Mensor will be final as to all matters concerning condition of the product, the cause and nature of a defect, and the necessity or manner of repair. Service, repairs or disassembly of the product in any manner, performed without specific factory permission, voids this warranty.

MENSOR MAKES NO WARRANTY OF ANY KIND WITH REGARD TO THIS MANUAL, INCLUDING, BUT NOT LIMITED TO, THE IMPLIED WARRANTIES OF MERCHANTABILITY AND FITNESS FOR A PARTICULAR PURPOSE. Mensor shall not be liable for errors contained herein or for incidental or consequential damages in connection with the furnishing, performance, or use of this material.

1.2 Important Notice



The product specifications and other information contained in this manual are subject to change without notice.

Notice

Any reproduction of this manual or parts thereof by any means is prohibited.

1.3 FCC Radio Frequency Emission Notice

This equipment has been tested and found to comply with the limits for a Class A digital device, pursuant to Part 15 of the FCC Rules. These limits are designed to provide reasonable protection against harmful interference when the equipment is operated in a commercial environment. This equipment generates, uses, and can radiate radio frequency energy and, if not installed and used in accordance with the instruction manual, may cause harmful interference to radio communications. Operation of this equipment in a residential area is likely to cause harmful interference in which case the user will be required to correct the interference at his or her own expense.

Use shielded cables to connect external devices to this instrument to minimize RF radiation.

1.4 Trademarks and Copyrights (C)

WIKA is a registered trademark of WIKA Alexander Wiegand SE & Co. KG.
Mensor is a registered trademark of Mensor. ©2012, Mensor. All rights reserved.



Notice

All other brand and product names are trademarks or registered trademarks of their respective companies.

1.5 Software License Agreement

This product contains intellectual property, i.e., software programs, that are licensed for use by the end user/customer (hereinafter “end user”).



Notice

This is not a sale of such intellectual property. The end user shall not copy, disassemble, reverse engineer or de-compile the software program.
The software programs are provided to the end user “as is” without warranty of any kind, either express or implied, including, but not limited to, warranties of merchantability and fitness for a particular purpose. The entire risk of the quality and performance of the software program is with the end user.

Mensor and its suppliers shall not be held to any liability for any damages suffered or incurred by the end user (including, but not limited to, general, special, consequential or incidental damages including damages for loss of business profits, business interruption, loss of business information and the like), arising from or in connection with the delivery, use or performance of the software program.

1.6 Mensor Service Plus

Mensor has made a concerted effort to provide complete and current information for the proper use of the equipment. If there are questions regarding this manual, proper use of the equipment, or if you have problems using your CPC8000 and you don't find the answer in this manual, contact either Mensor or WIKA for personal assistance. We are ready to help.

Mensor
201 Barnes Drive
San Marcos, Tx 78666
tel: 1-512-396-4200
1-800-984-4200 (USA only)
fax: 1-512-396-1820
email: sales@mensor.com
tech.support@mensor.com
website: www.mensor.com

WIKA Alexander Wiegand SE & Co. KG
Alexander-Wiegand-Straße 30
63911 Klingenberg / Germany
tel: +49 9372/132-5015
fax: +49 9372/132-8767
email: CTSales@wika.de
CTService@wika.de
website: www.wika.de

1.6.1 After the Warranty

Mensor's concern with the performance of this instrument is not limited to the warranty period. We provide complete repair, calibration and certification services after the warranty for a nominal fee as explained in [Section 10, Maintenance](#).

1.6.2 Calibration Services

In addition to servicing our own products, Mensor provides complete pressure calibration services up to 30,000 psi for many pressure instruments. This service includes a Certificate of Compliance and Calibration and a record of traceability to the pressure standards of the United States National Institute of Standards and Technology (NIST).

1.6.3 Accreditations

Mensor is registered to ISO 9001:2008. The calibration program at Mensor is accredited by A2LA, as complying with both the ISO/IEC 17025:2005 and the ANSI/NCSL Z540-1-1994 standards.

1.7 Packaging for Shipment

If the product must be shipped to a different location or returned for any reason through a common carrier it must be packaged properly to minimize the risk of damage.

The recommended method of packing is to place the instrument in a container, surrounded on all sides with at least four inches of shock attenuation material such as styrofoam peanuts.

If the instrument will be subjected to frequent transport then the optional Transport Case shown in [Section 9, Options](#), might be an economical solution. This wheeled case is very rugged and provides complete and long term protection against rough handling.

2 Safety Notices

2.1 User Responsibilities

To ensure safety, the operator must make sure that the following conditions are met:

- The system is used properly, no dangerous media are used and that all technical specifications are observed.
- The system is in perfect operating condition.
- The operation manual is legible and accessible to the user at the system's location.
- The system is operated, serviced and repaired only by authorized and qualified personnel.
- The user receives instruction on industrial safety and environmental protection, and is knowledgeable of all operating instructions and safety notices relevant to the current procedure.

2.2 General Safety Notices



Notice

The system should be operated only by trained personnel who are familiar with this manual and the operation of the instrument.



Warning

A condition for trouble-free and safe operation of this system is proper transport, proper storage, installation, assembly and proper use as well as careful operation and maintenance.

Any operation not described in the following instructions should be prohibited. The system must be handled with care required for an electronic precision instrument (protect from humidity, impacts, strong magnetic fields, static electricity and extreme temperatures). Do not insert any objects into the instrument.

The system is powered via the power cable with a voltage that can cause physical injury. Even after disconnecting the system from the power supply, dangerous voltages can temporarily occur due to capacitance.

Repairs must be performed only by authorized service personnel.



Notice

Additional safety notices are found throughout this manual.

2.3 Warnings and Caution Notices



WARNING: HIGH PRESSURE! High pressure gases are potentially hazardous. Energy stored in these gases can be released suddenly and with extreme force. High pressure systems should be assembled and operated only by personnel who have been trained in proper safety practices.



WARNING: POSSIBLE INJURY! The tubing, valves and other apparatus attached to the instrument must be adequate for the maximum pressure which will be applied, otherwise physical injury to the operator or bystanders is possible.



CAUTION: Use the proper pressure medium. Use only clean, dry, noncorrosive gases. This instrument is not designed for oxygen use.



WARNING: HIGH SOUND LEVELS! Pressures from 1000 psi and up can generate sound levels above 80 dbA for brief periods when they are exhausted directly to atmosphere. A muffler is provided for connection to the vent port. It is the operator's responsibility to measure sound levels at whatever point 1 meter from the equipment that has the highest sound pressure level. At levels above 80 dbA, use of protective ear pieces can reduce these higher levels to a safe level.



WARNING: NOT EXPLOSION PROOF! Installation of this instrument in an area requiring devices rated as intrinsically safe is not recommended.



WARNING: Detachable main power supply cord with inadequate ratings should not be used. See Section 4.0, Specifications, for power supply ratings.



CAUTION: ESD PROTECTION REQUIRED. The proper use of grounded work surfaces and personal wrist straps are required when coming into contact with exposed circuits (printed circuit boards) to prevent static discharge damage to sensitive electronic components.

Additional Warning and Caution notes are included throughout this manual.

3 Product Description

3.1 General Description

The CPC8000 High-End Pressure Controller is our highest performance pressure controller and features the following:

- 19" rack mount compatibility
- Designed for serviceability and reliability
- Widescreen display with glass capacitive touchscreen
- Front panel door gives access to instrument interior
- Up to three removable transducers 0.01% IS-50 (IntelliScale-50)
- Pressure ranges from 5 psi to 6,000 psi, up to 10:1 turndown
- Adaptive control algorithm with rate control capability
- Ethernet, RS-232, USB, and IEEE-488 communications
- Remote compatibility with PCS 400, CPC 6000, CPC 3000, old CPC8000 (SCPI)
- Emulation of competitive instrument command sets
- Local program capability
- Multiple language support
- On board diagnostic logging
- Barometric reference option
- 0.008% IS-33 (IntelliScale-33) transducer option
- Complies with latest CE and 61010 regulations

The CPC8000 is designed to automate the testing and calibration of all types of pressure devices and instruments. Up to three removable / interchangeable pressure transducers are available in full scale (FS) ranges from 5 to 6,000 psig, 7.5 to 6015 psia. Each transducer module is configured with its own calibration parameters on board and have 0.01% IS-50 or optional 0.008% IS-33 accuracy.

The three transducers, in combination with the internal control valve regulator, provide a dynamic output. The operator can choose to control pressure either using a single, selected transducer or auto-range control across all three transducers. The ratio between the highest FS range and the lowest FS range within the CPC8000 cannot exceed 10:1. The three ranges can be chosen to optimise accuracy levels across the full pressure span of the instrument.

In addition to the capacity for three active ranges, a fourth, barometric transducer is available as an option. With this option installed a CPC8000, with absolute or gauge pressure transducers, can emulate pressure of the opposite type.

3.1.1 IntelliScale Transducer Choices

The CPC8000 can be supplied with standard 0.01% IS-50 Transducers or optional 0.008% IS-33 transducers to give a percent of reading accuracy down to 50% or 33% of full scale respectively. Refer to [Section 4, Specifications](#), for a full description of the accuracy specification and [Section 4.7, IntelliScale](#).

3.2 Front Panel

The front of the CPC8000 has a smooth, uncluttered appearance (see figure 3.2). Its main feature is the large color display plus an identification label in the lower right corner of the display panel. The display panel is hinged for easy access to remove or replace the transducer modules inside. The instructions for accessing the transducers are provided in [Section 10.2.2 Transducer removal/replacement](#). Immediately to the right of the display panel is a USB port and a power switch.



Figure 3.2 - Front View

3.2.1 Power Switch

The power switch is a two-state device with an action similar to that of a ball point pen. Push the button with enough force to latch it in to turn the unit ON. Push it again to release it to turn the system OFF.



If power to the instrument is interrupted while ON it will shut down until the power is restored, **then immediately resume operation.**

Notice

3.2.2 USB Port

The front panel USB port is the same as the Host USB port on the rear panel. Both are intended for future expansions or software upgrades

3.2.3 Information Label

The front panel label identifies the instrument name, installed transducer ranges in the pressure units specified by the customer, and the serial number.

3.2.4 Screen

The large (9 inch diagonal) LCD color screen has a glass capacitive touch screen for navigation within the intuitive operator interface. At power up the main screen is presented. ([See figure 3.2.4.1](#))

3.2.4.1 Main Screen Features

On power up, the main screen will show a numeric data entry key pad on the right 1/3 of the display and pressure range, control and operating parameters on the left 2/3.

The data entry key pad can be switched between 4 different methods for data entry. See [Section 6, Local Operation](#), for more details. The data entry portion of the main screen is used primarily to input and adjust control set points and change main screen parameters.

The left 2/3 of the main screen (see figure 3.2.4.1) contains the reading of the internal pressure transducer, current configuration settings, range limits and labels (see [Section 6, Local Operation](#), for more details). Pressure monitoring calibration and testing functions are performed through Interaction with this screen; the majority of an operator's local operation time will be spent working with this screen. A map of the individual features on the various displays is included in [Section 6.1.2](#).

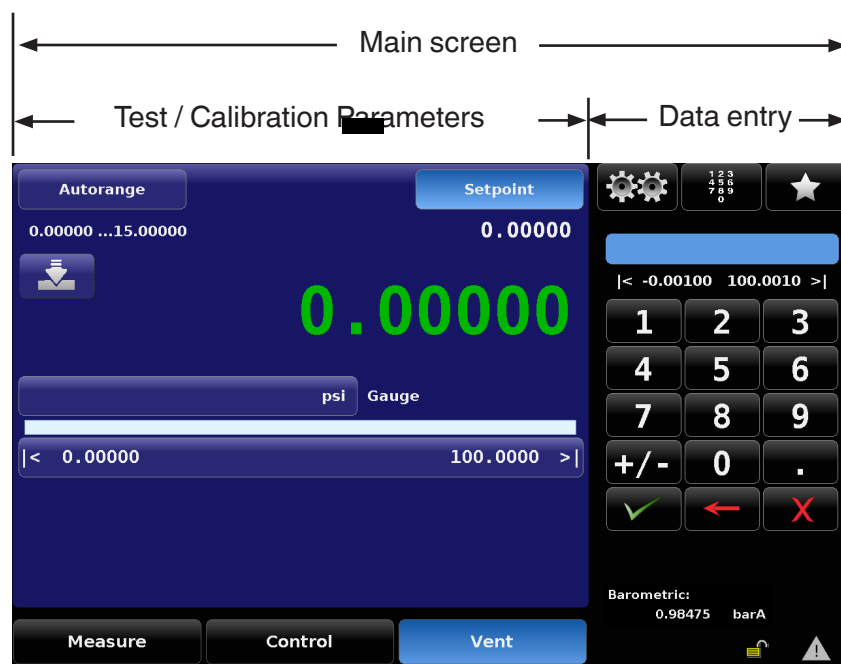



Figure 3.2.4.1 - Main Screen Features

3.2.4.2 Screen Navigation

Individual screens are accessed by a series of touches on tabs, buttons or icons, which open screens within the hierarchy of the instrument. Nomenclature that designated a screen and how to navigate to it will be given in this manual in the following structure: “**Icon name**” [Icon Graphic] / [Tab] / [Button Name].

For example the screen used to set the resolution of the instrument transducer would be designated by the navigational screen hierarchy, starting from the main screen, as follows: **Setup** [] / [Sensor] / [Resolution]. This convention is similar to a computer folder system and will be used to describe a screen and, inherently, how to navigate to it.

All of the screens are set up into two display areas. The larger area (left 2/3 of the screen) shows live information about the current configuration, the progress of the test being performed and gives an indication of the output of the device. The smaller area (Data Entry) on the right side, has the number key pad, variable sliders or discrete choice buttons (radio buttons) that all act to input alpha numeric information or mode changes relating to the test or calibration information being shown on the left.

Buttons on the screen are shown with a gradient background. When inactive the buttons are shown with the gradient dark on the bottom and light on the top; when selected the button changes color and is light on the bottom and dark on the top. Buttons are labeled in an intuitive fashion and when selected its function is obvious.

The setup screens are accessed by pressing the double gear icon [] and follows the same format as the main screen with the right hand side used for data entry and the left hand side used for display. These setup screens are used for a variety of instrument settings, including, display, transducer, control, and remote interface settings. This area also contains the application used to calibrate the internal transducers plus various administrative, information and configuration settings. Detailed information about all setup screens can be found in [Section 6, Local Operation](#).

Touch the left pointing arrow [◀] in the bottom left corner of any setup screen to return to the main screen.

Full operational descriptions of all of the screens, symbols, labels and switches are provided in [Section 6, Local Operation](#).

3.3 Main Features

- Up to three, highly stable removable / interchangeable pressure transducers (see Section 10.2.2, Transducer Removal/Replacement). Each transducer is a totally self-contained module including its unique calibration data.
- IntelliScale calibrations for maximum accuracy specifications.
- An optional high performance Barometer module can be used for accurate emulation of gauge pressure with absolute pressure instruments, or used for absolute pressure emulation with gauge pressure instruments.
- A large 9- inch diagonal color LCD with glass capacitive touch screen for intuitive operator interface.
- A very quiet precision pressure regulator with a fast response time.
- Multiple languages; simply touch one of the national flags on the display to instantly change the on-screen text language, and the corresponding number and date formats. For more detailed information see Section 7.1.1, Language.

4 Specifications

Accuracy specifications presented herein are obtained by comparison with primary standards traceable to the National Institute of Standards and Technology (NIST). A calibration data report has been provided with your new CPC8000 instrument, traceable to NIST. The calibration program at Mensor is accredited to both ISO/IEC 17025:2005 and Z540-1-1994 by A2LA. Mensor, LP is registered to ISO 9001:2008.

Mensor reserves the right to change these specifications without notice.

4.1 Measure Specifications

Reference pressure transducer model CPR8000/ CPR8800	
Accuracy ⁽¹⁾	0.01% FS ⁽³⁾ , 0.01% IS-50 ⁽²⁾ -or- Optional 0.008% IS-33 ⁽⁴⁾ Optional 0.008% IS-50 ⁽⁵⁾ .
Pressure ranges	0 ... 7.5 psia to 0 ... 6015 psia ⁽⁶⁾ 0 ... 5 psig to 0 ... 6000 psig ⁽⁷⁾ -15 ... 15 psig to -15 ... 6000 psig ⁽⁷⁾ See Table 4.6.1 for available Transducer Type, Range, Mode, Accuracy and Calibration interval Maximum ratio between highest and lowest range is 10:1
Precision ⁽⁸⁾	0.004% FS
Measurement units	psi, inHg@0C, cmHg@0C, mmHg@0C, inH2O@4C, 20C, bar, mbar, cmH2O@4C and 20C, hPa, kPa, Pa, MPa, kg/cm sq, and 2 user-defined units. All above in rate (per second, per minute and per hour).
Resolution	Operator selectable from 4 to 7 digits depending on the range, units and selected transducer
Calibration adjustments	Zero adder and Span multiplier or up to 11 point linearization for each transducer
Calibration interval	365 days ⁽⁹⁾
Calibration data storage	The calibration data is stored on the transducer.
Measurement filters	Off, low, normal (default), high
Optional barometric reference	
Function	The barometric reference can be used to switch pressure types ⁽¹⁰⁾ , absolute <=> gauge. With gauge pressure transducers, the measuring range of the transducers must begin with -1 bar (-15 psi) in order to carry out a complete absolute pressure emulation
Measuring range	8 ... 17 psia
Accuracy ⁽¹⁾	0.01 % of reading
Precision ⁽⁸⁾	0.004% FS

(1) It is defined by the total measurement uncertainty, with the coverage factor (k = 2) and includes the intrinsic performance of the instrument, the measurement uncertainty of the reference instrument, long-term stability, influence of ambient conditions, drift and temperature effects over the compensated range with recommended zero point adjustment every 30 days.

(2) 0.01 % IS-50 accuracy: Between 0 ... 50 % of the full scale, the accuracy is 0.01% of half of the full scale value and between 50 ... 100 % of the full scale, the accuracy is 0.01 % of reading.

(3) FS = full span.

(4) 0.008 % IS-33 accuracy: Between 0 ... 33 % of the full scale, the accuracy is 0.008% of one third of the full scale value and between 33 ... 100 % of the full scale, the accuracy is 0.008 % of reading.

(5) 0.008 % IS-50 accuracy: Between 0 ... 50 % of the full scale, the accuracy is 0.008% of half of the full scale value and between 50 ... 100 % of the full scale, the accuracy is 0.008 % of reading.

(6) The minimum calibrated range of absolute transducer(s) is 600 mTorr.

(7) Ranges from 1500 to 2000 psig will be sealed gauge transducers.

(8) It is defined as the combined effects of linearity, repeatability and hysteresis throughout the stated compensated temperature range.

(9) 365 days for 0.01% IS-50, 0.008% IS-33 and 0.008% FS accuracy. For 0.01% FS accuracy, 180 days for pressure ranges below 1 bar (15 psi) gauge or absolute, and -1 ...1 bar (-15 ... 14.5 psi) bidirectional. 365 days for the remainder of the specified ranges

(10) For a pressure type emulation, we recommend a native absolute pressure transducer, since the zero point drift can be eliminated through a zero point adjustment.

4.2 Control Specifications

External pressure requirements	Source Requirements – 10% over range of highest pressure transducer Exhaust Requirements – Vacuum source required for any control below atmosphere
Control stability	0.002% FS of highest range transducer at the set point
Pressure range ratio	Maximum ratio between highest and lowest range is 10:1
Minimum control pressure	0.05% FS of highest range transducer or .025 psi over exhaust pressure, whichever is greater
Pressure control rates	0.001% of range/sec to 10% of range/sec
Control time	60 seconds to stable flag for a 10% pressure change into 150cc volume. Larger volumes can lengthen this time. Controlling to pressures less than 0.5 psia will lengthen this time.
Supply consumption	<2.5 scfh in steady-state control.
Overshoot	<0.1% FS of highest range transducer
External volume	50 to 300 cc. (Consult factory for volumes exceeding 300 cc). Requires one complete pressure cycle after changing the external volume, or after a power cycle. See page 27, “Turning on the CPC8000”.

4.3 General Specifications

Size	See Section 5.3, Dimensions .
Weight	~49 lbs (~22.2 kg) with all internal options.
Mounting	Standard: desk top case with bezel and handle. Optional: 19” rackmount kit.
Power input requirements	100 – 120 VAC / 200 – 240 VAC, 50 – 60 Hz
Energy Consumption	Max 130 VA
Pneumatic interfaces	7/16-20 female SAE threaded ports for Measure/Control, Exhaust, Vent, Reference, and Supply. Hose barb for barometer. Other fittings per customer request.
Particle filters	The instrument has 40-micron filters on all pressure ports through the manifold. The barometer has no filters
Permissible pressure media	Dry, clean air or nitrogen (ISO 8573-1:2010 class 5.5.4 or better)
Pneumatic overpressure protection	Each transducer is protected with pneumatic relief valves set 10-25% over the maximum transducer pressure.
Compensated temp. range	15 to 45 °C
Operating temp. range	0 to 50 °C
Storage temp. range	0 to 70 °C
Local user interfaces	9” Color LCD with glass capacitive touch screen
Remote user interface	RS-232 (null modem cable not required), Ethernet, USB, and IEEE 488.2
Warm-up	15 minutes
Reading rate	32+ readings/second, unique readings/second is transducer dependent.
Transducer Response time	< .33 seconds after a 0-FS step
Orientation effects (tilt)	Negligible, can be removed with re-zeroing. (calibrate and operate in a horizontal position)
Shock / vibration	2 G’s Max
Pressure media capability	Clean, dry, non-corrosive, non-combustible, non oxidizing gases. No oxygen.
Metals in contact with media	6000 series Aluminum, 316 SS, Brass
Non-metals in contact with media	Teflon, Urethane, Silicone, RTV, Silicone grease, PVC, Epoxy, Ceramics

High-End Pressure Controller CPC8000

Operating environment	0-95% RH, non-condensing
CE mark	Conformity certificate. Complies with EN61326-1 and EN61010-1.
RoHS directive	Complies with 2011/65/EU, article 4
Calibration certificate	Includes calibration certificate(s). The Mensor calibration laboratory is accredited in accordance with the recognized International Standard ISO/IEC 17025:2005 and also meets the requirements of ANSI/NCSL Z540-1-1994. Accreditation is by the American Association for Laboratory Accreditation (A2LA).
Warranty	Two year warranty
Options	0.008% IS-33, IS-50 transducer option Transport/travel case Barometric reference transducer Spare Primary, Secondary or Tertiary transducer 19" rackmount kit



WARNING! This is class A equipment for emissions and is intended for use in industrial environments. In other environments, e.g. residential or commercial installations, it can interfere with other equipment under certain conditions. In such circumstances the operator is expected to take the appropriate measures.

4.4 Transducer Removal/Replacement



When replacing transducers the order of position **MUST** be maintained according to the pressure limit of each transducer; starting with the highest pressure transducer on the left (Primary Transducer), and the next lower pressure limit transducer next (Secondary Transducer), and the low ranged transducer at the far right (Tertiary Transducer). If the system will be operated with less than the full complement of three pressure modules, any empty slots must begin at the far right where the Tertiary Transducer is normally located.

The manifold seal is a metal plate used to seal the pneumatic openings on the manifold at an unused transducer slot. If there is just a single pressure transducer installed then two manifold seals are installed. All transducer slots must be sealed with either transducers or seal plates for the instrument to function. Two manifold seal plates are shipped with each unit for this purpose.

The D-sub connectors for unused slots can remain unplugged. For more information on transducer removal/replacement [see Section 10.2.2](#) in the Maintenance section.

Up to three transducers can be present within the CPC8000. The full scale pressure of the highest ranged transducer (the Primary transducer) must fall within the range of the installed regulator module ([see Table 4.5, Regulator Module version and range limits](#)). This primary transducer occupies the left-most slot within the CPC8000 (see figure 4.4). The other two slots can be empty or occupied with lower ranged transducers but their full scale range cannot exceed a ratio of 10:1 of the primary transducer. In other words, the lowest full scale range in the CPC8000 cannot be less than one tenth of the range of the primary transducer full scale range ([see Section 4.6, Transducer Choices](#)).

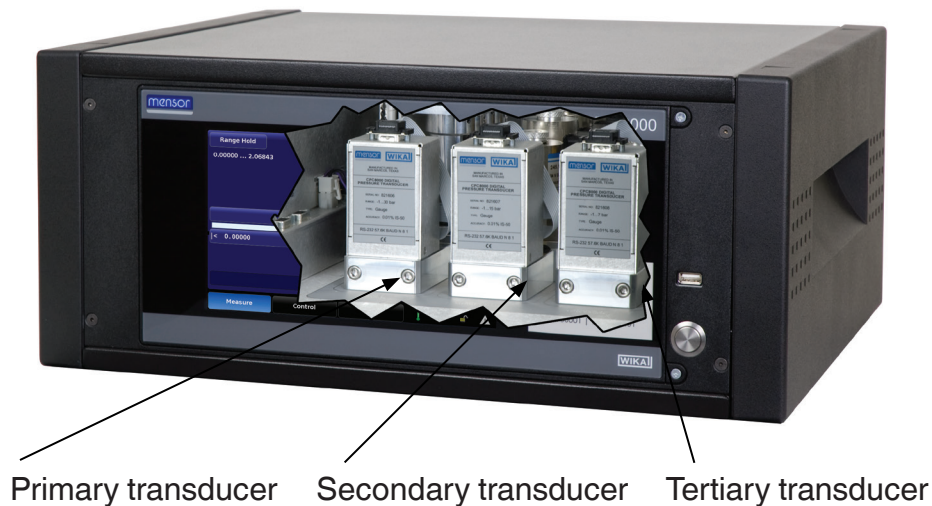

Figure 4.4 - Front cut-away view showing three transducers

4.5 Regulator Ranges

The CPC8000 is supplied with one of five different needle valve regulators (NVR) modules. Table 4.5 shows each regulator and its corresponding pressure range limits: LP (low pressure), MP (medium pressure), SP (standard pressure), HP (high pressure) and EP (extended pressure).

Table 4.5 - Regulator Module Version and Range Limits

Regulator Module	Primary Range Limits
LP-NVR	≤ 90 psi gauge or 105 psi absolute / 6 bar gauge or 7 bar absolute
MP-NVR	≤ 1000 psi gauge or 1015 psi absolute / 70 bar gauge or 71 bar absolute > 90 psi gauge or 105 psi absolute / 6 bar gauge or 7 bar absolute
SP-NVR	≤ 2000 psi gauge or 2015 psi absolute / 135 bar gauge or 136 bar absolute > 1000 psi gauge or 1015 psi absolute / 70 bar gauge or 71 bar absolute
HP-NVR	≤ 3000 psi gauge or 3015 psi absolute / 210 bar gauge or 211 bar absolute > 2000 psi gauge or 2015 psi absolute / 135 bar gauge or 136 bar absolute
EP-NVR	≤ 6000 psi gauge or 6015 psi absolute / 400 bar gauge or 401 bar absolute > 3000 psi gauge or 3015 psi absolute / 210 bar gauge or 211 bar absolute

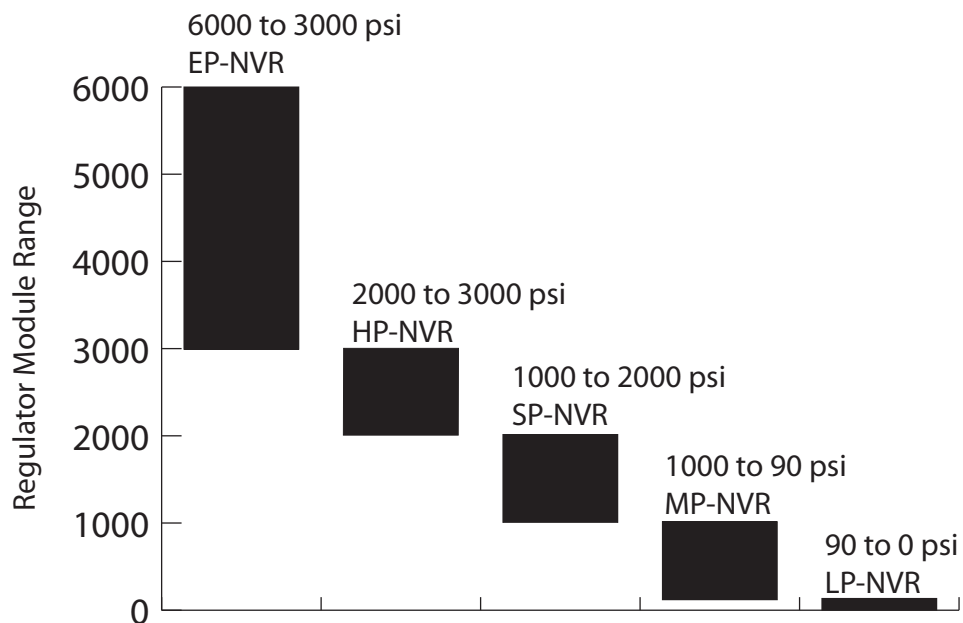

Figure 4.5 - Primary transducer limit for each regulator

The primary transducer (Transducer 1) full scale range must fall within one of the regulator range limits shown in figure 4.5. The secondary and tertiary transducers may fall outside of these limits but must not have a full scale value less than 1/10 of the primary transducer full scale range.

4.6 Transducer Choices

Transducer measuring modes can be gauge, absolute, or bi-directional. The CPC8000 will be equipped with one, two or three transducers of the same mode. Transducer type will be “Standard” (accuracy of 0.01% FS, or 0.01% IS-50) or “Premium” (accuracy of 0.008% IS-33, or 0.008% IS-50). **The transducers must be all “Standard” transducers or all “Premium” transducers and not a mix of both types.**

The three transducers, in combination with NVR Module, provide a wide dynamic range (10:1 FS) where the operator can choose to control output pressure using a single transducer, or “autorange” control across all three transducers. The three transducer ranges can be chosen to optimize accuracy levels. Full scale transducer ranges up to 6000 psi are available plus an optional barometric transducer. The accuracy specifications, plus a proprietary needle valve regulator, provides accurate and stable control.

The number of unique readings/sec over the remote interface is dependent on the transducer type. The transducer update rate of a standard transducer is 30ms, or 33 unique readings/sec. The transducer update rate of a premium transducer is 100ms, or 10 unique readings/sec. This is a technical limitation of the premium transducer required to meet performance specifications. All remote protocols can query faster than the transducer update rate.

An optional precision barometer can be used for emulation of gauge pressure with an absolute pressure instrument, or used for absolute pressure emulation with a gauge pressure instrument. For full range absolute emulation, the instrument gauge transducers should be ranged down to -15 psig.

Table 4.6 - Transducer Choices

Transducer 1	
CPR8000 Standard Transducer	0.01% FS or 0.01% IS-50
CPR8800 Premium Transducer	0.008% IS-33 or 0.008% IS-50
Transducer 2	
No second reference transducer	
CPR8000 Standard Transducer	0.01% FS or 0.01% IS-50
CPR8800 Premium Transducer	0.008% IS-33 or 0.008% IS-50
Transducer 3	
No third reference transducer	
CPR8000 Standard Transducer	0.01% FS or 0.01% IS-50
CPR8800 Premium Transducer	0.008% IS-33 or 0.008% IS-50

4.6.1 Transducer Type / Range / Mode / Accuracy

Each transducer within the CPC8000 or additional transducers will conform to the limits shown in the following table.

Table 4.6.1 - Transducer Type / Range / Mode / Accuracy

Standard Transducer (Model CPR8000) Ranges		Mode	Accuracy
0 ... 5 to 0 ... <14.5 psig		Gauge	0.01% FS – 180 days
0 ... ≥14.5 to 0 ... 6000 psig		Gauge	0.01% IS-50 – 365 days
0 ... 7.5 to 0 ... <14.5 psia		Absolute	0.01% FS – 180 days
0 ... ≥14.5 to 0 ... 6015 psia		Absolute	0.01% IS-50 – 365 days
Min span	Max span		
-5 ... 5 psi	-15... +14.5 psi	Bidirectional	0.01% FS – 180 days
-15 ... ≥14.5 psi	-15 ... <145 psi	Bidirectional	0.01% FS – 365 days
-15 ... ≥145 psi	-15 ... + 6000 psi	Bidirectional	0.01% IS-50 – 365 days
Premium Transducer (Model CPR8800) Ranges		Mode	Accuracy
0 ... 12 to 0 ... 16.5 psi		Gauge	0.008% IS-33 – 365 days
0 ... 17.5 to 0 ... 24 psi		Gauge	0.008% IS-33 – 365 days
0 ... 24.1 to 0 ... 33 psi		Gauge	0.008% IS-33 – 365 days
0 ... 80 to 0 ... 110 psi		Gauge	0.008% IS-33 – 365 days
0 ... 120 to 0 ... 165 psi		Gauge	0.008% IS-33 – 365 days
0 ... 165.1 to 0 ... 220 psi		Gauge	0.008% IS-33 – 365 days
0 ... 12 to 0 ... 16.5 psia		Absolute	0.008% IS-33 – 365 days
0 ... 18.4 to 0 ... 33 psia		Absolute	0.008% IS-33 – 365 days
0 ... 36 to 0 ... 50 psia		Absolute	0.008% IS-33 – 365 days
0 ... 80 to 0 ... 110 psia		Absolute	0.008% IS-33 – 365 days
0 ... 160 to 0 ... 220 psia		Absolute	0.008% IS-33 – 365 days
0 ... 240 to 0 ... 500 psia		Absolute	0.008% IS-33 – 365 days
0 ... 700 to 0 ... 1100 psia		Absolute	0.008% IS-50 – 365 days
0 ... 1400 to 0 ... 3300 psia		Absolute	0.008% IS-50 – 365 days
0 ... 4200 to 0 ... 6015 psia		Absolute	0.008% IS-50 – 365 days

4.7 IntelliScale

IntelliScale is a calibration technique that provides another degree of certainty to a pressure measurement specification. Or said another way, IntelliScale is designed to further reduce the accuracy specification. It does this by considering the full pressure range as two separate ranges; a specifically defined lower range, and the remaining upper range. It then defines the accuracy of the lower portion as a percent of the full scale of that lower range, and the accuracy of the upper portion as a percent of reading at any pressure point within that upper range.

In practice, the standard Mensor IntelliScale specification is 0.01% IS-50. This means that the full scale lower half (50% of the total range) has an accuracy of 0.01% of that portion of the range, while the upper half of the total range has an accuracy of 0.01% of the pressure reading. Thus, any pressure within the lower half of the pressure range has a fixed number for the accuracy (.01% of that half scale), while the accuracy anywhere in the upper half of the full range is a sliding scale number; that is, a percent (0.01%) of any reading.

For example, a device with a pressure range from 0 to 100 psi with an accuracy specification of IntelliScale 0.01% IS-50 will have an accuracy of 0.005 psi (0.01% x 50 psi FS) on any pressure from 0 psi to 50 psi, and an accuracy of 0.01% of reading (0.01% x R) for any pressure above 50 psi (see figure 4.7.1a).

4.7.1 Optional IntelliScale

An option available for some ranges is IntelliScale 0.008% IS-33, where the lower portion of the full scale range is 33% of the total range, and the upper portion of the full scale range is 67% of the full range. The result is an accuracy of 0.00264% (0.008% x 33% FS) of the total full scale pressure for the one third low end range, and an accuracy of 0.008% of reading (0.008% x R) for any pressure in the upper two thirds of the transducer range. See figure 4.7.1b.

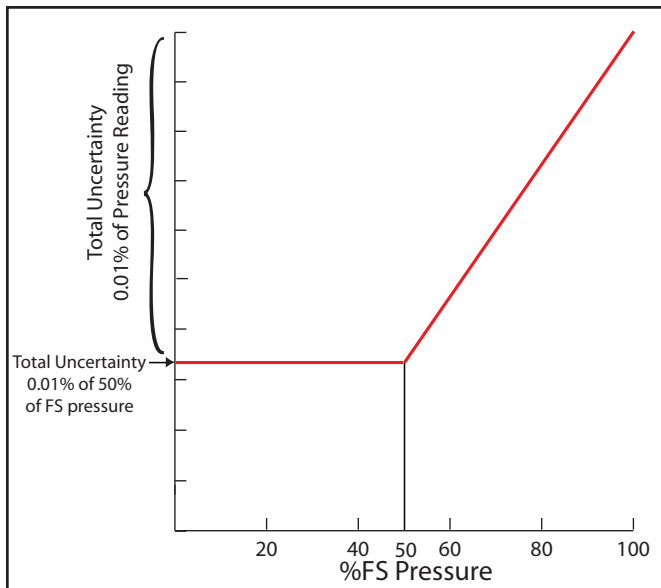

Figure 4.7.1a - IntelliScale IS-50

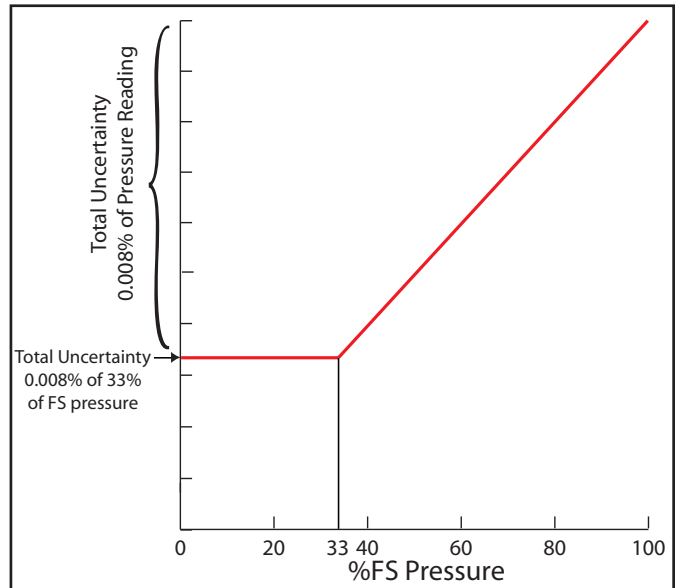

Figure 4.7.1b - IntelliScale IS-33

5 Installation



WARNING: READ THESE INSTRUCTIONS BEFORE INSTALLATION!

The installation location must meet the following conditions (see also [Section 4, Specifications](#)):

- Ambient temperature: Compensated temperature range 15° to 45° C
- Humidity: 0-95% relative humidity, non-condensing
- Flat, horizontal location; secure fixed working surface (desk top model) or proper installation in a sturdy 19" mounting rack or cabinet
- Sufficient air circulation must be provided at the rear of the instrument to avoid accumulation of heat
- Pressure Supply Requirements:
- Stable supply pressure 10% higher than the full scale of the controller
- Permissible media: dry, clean air or nitrogen
- Vacuum: minimum 50 liters per minute (if required)

5.1 Initial Installation

The initial installation of the CPC8000 includes the following steps: Unpack the system, place it in a suitable work place, connect it, switch it on and configure.

A Quick Start Guide has been placed inside the shipping box containing your instrument. This guide provides a quick reference to the pneumatic and electrical connections and an introduction to the operator interface. It is intended for experienced operators. All safety precautions within this manual should be understood and followed.

5.2 Unpacking the system

Your new instrument was subjected to many hours of functional testing before it left the factory. In addition to testing, the unit was inspected for appearance prior to being packaged for shipment. Upon removal from its carton please examine the instrument for shipping damage. Report any apparent damage to the carrier immediately.

Apart from any additional components ordered, a shipment consists of:

- CPC8000 High-End Pressure Controller
- Power Cord
- Operating Manual
- Quick Start Guide
- Any options ordered
- Two manifold seal plates (either attached internally or sent externally with the CPC8000)
- An envelope containing the Calibration Certificate
- A 3/16 hex screwdriver
- A microfiber cloth to clean the glass front panel
- Muffler, if pressure ranges \geq 1000 psi (70 bar)

5.3 Dimensions

DESK TOP:

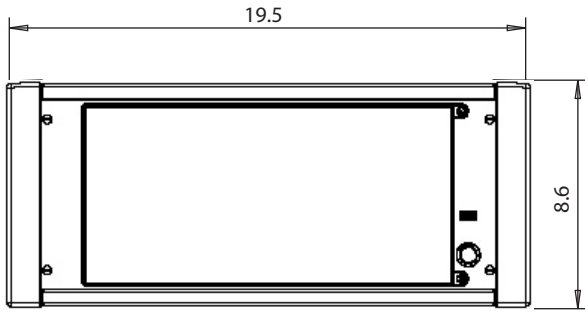

front view

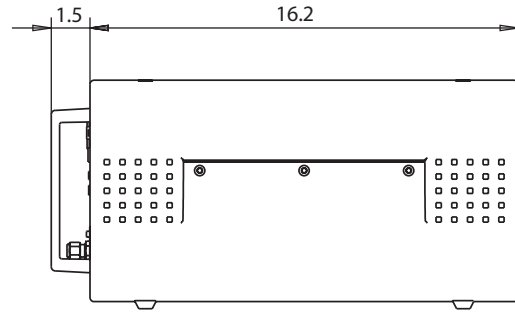

side view

RACK MOUNT:

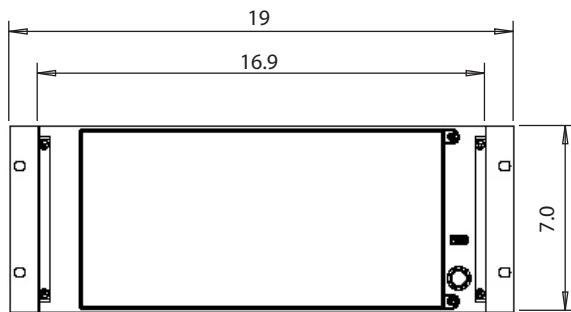

front view

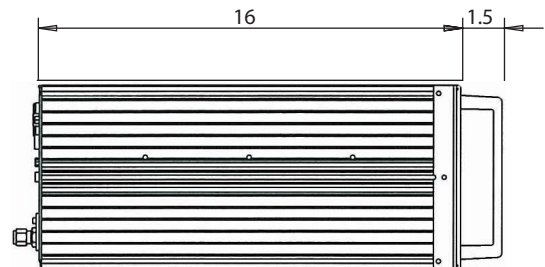

side view

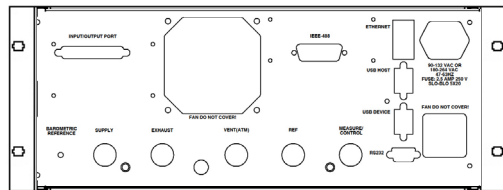

rear view

Adaptor Fitting:
1/4 in. Tube OD x 7/16-20 Male SAE/MS Straight Thread
-OR-
6 mm Tube OD x 7/16-20 Male SAE/MS Straight Thread

5.4 Turning on the CPC8000

After the pressure connections are secure in accordance with Section 5.5 below, apply power to the power connector on the rear of the instrument and switch the power switch ON. The instrument will go through an initialization process and system check. As soon as the system check is completed the system will default to an operating screen similar to the screen shown in [Section 3.2, Front Panel](#). Allow the instrument at least 30 minutes of warm up time before performing critical pressure measurements.



Warning

Earth Ground! Any power adaptors or surge protection devices that negate the protective earth ground should not be used. The power cord must be accessible and contain a protective earth ground.

Ventilation! Do not block airflow to ventilating fans located on rear of instrument.

The instrument can be set up on a table top or it can be rack mounted. Rack mount adapters are optional.

After the controller has warmed up, cycle the pressure from the minimum to the maximum then back to the minimum pressure of the primary transducer with the desired volume connected to the Measure/Control port. This will allow the controller to properly compensate for the difference in external volume between what was used at the factory versus what is currently in use. This pressure cycle should occur after each power cycle, or when the external volume size has been changed.

5.5 Pressure Connections



Warning

Warning! The pressure connections must be installed according to the following instructions, observing the relevant regulations. The installation is to be performed by trained, authorized personnel, knowledgeable in the safety regulations for working on pneumatic/hydraulic systems.



Notice

Up to 6 pressure connections are on the rear panel. Pressure connections that are not assigned are plugged.

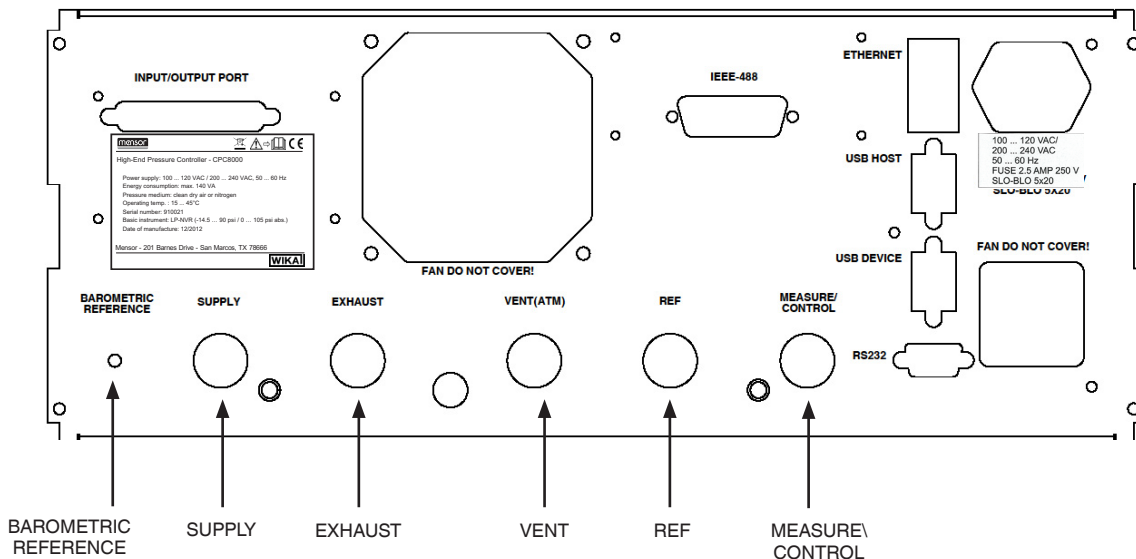

Figure 5.5 - Pressure Connections

5.5.1 Supply

The pressure supplied to the pressure connection labeled “Supply” should be approximately 10% higher than the full scale of the highest pressure transducer installed in the controller (see the label on the lower right of the front panel).

5.5.2 Exhaust

The pressure connection labeled “Exhaust” is for the vacuum supply. In a gauge pressure version it can be left open to atmospheric pressure.

If the instrument’s primary pressure range has the minimum pressure in the vacuum region but is not negative atmosphere, a vacuum regulator will be included. The vacuum regulator included (6100500023) will need to be connected in-line between a vacuum pump and the exhaust port of the instrument in order for the instrument to control properly. This vacuum regulator will need to be set to 10% below the minimum range of the primary transducer of the instrument. The vacuum regulator can be set using a flat-head screwdriver.

5.5.3 Vent

The pressure connection labeled “Vent” is the exhaust port where the system pressure is vented to the atmosphere under certain conditions. Leave this port open or connect the optional muffler for noise reduction.

5.5.4 Reference

This is the pressure connection to the reference ports of transducers with ranges <50 psi (4 bar) gauge.



The Reference port should be left open to the atmosphere and should NEVER be connected to a pressure source.

Notice

The higher the supply pressure connected to the Supply port, the higher the pressure which leaves the system through the exhaust port. If a vacuum pump is connected to the exhaust port, adequate safety precautions have to be taken to prevent damage to the pump.

If vacuum is connected to the Exhaust port of the controller, negative pressure peaks might occur at the Measure/Control port for a very short time, when changing from the Measure mode to the Control mode.

Before the system is connected, the user must ensure that suitable protection measures are in place which exclude overpressuring of the test piece or the system.

5.5.4.1 Measure/Control

The Measure/Control port (when in the Control mode) supplies pressure that is precisely controlled by the controller. In the Measure mode a pressure applied to the Measure/Control port is measured by the instrument transducer.

5.5.4.2 Barometric Reference

The Barometric Reference port is connected to the internal barometric transducer and should be left open to atmospheric pressure.

5.6 Pneumatic Connections and Pressure Fittings

The CPC8000 is supplied with five 1/4 in. tube OD x 7/16-20 male SAE/MS straight thread adaptors or five 6 mm tube OD x 7/16-20 male SAE/MS straight thread adaptors (per order). The 7/16-20 male SAE/MS straight thread end of the adaptors should be connected to the instrument's 7/16-20 female SAE/MS straight thread connections. The adaptors need only be "wrench tight" for proper sealing. Connections should be made according to your specific requirements (for example, a vacuum pump is only required when controlling to a subatmospheric pressure).



Notice

For functional testing and to become familiar with the operation of the CPC8000, a volume close to the volume expected during normal operation can be connected to the Measure/Control port.



Warning

WARNING! The user must ensure that released pressure medium does not endanger personnel, environment or the instrument.



Notice

Test items with large volumes or long piping runs with small diameter tubing can have a negative effect on the control performance.

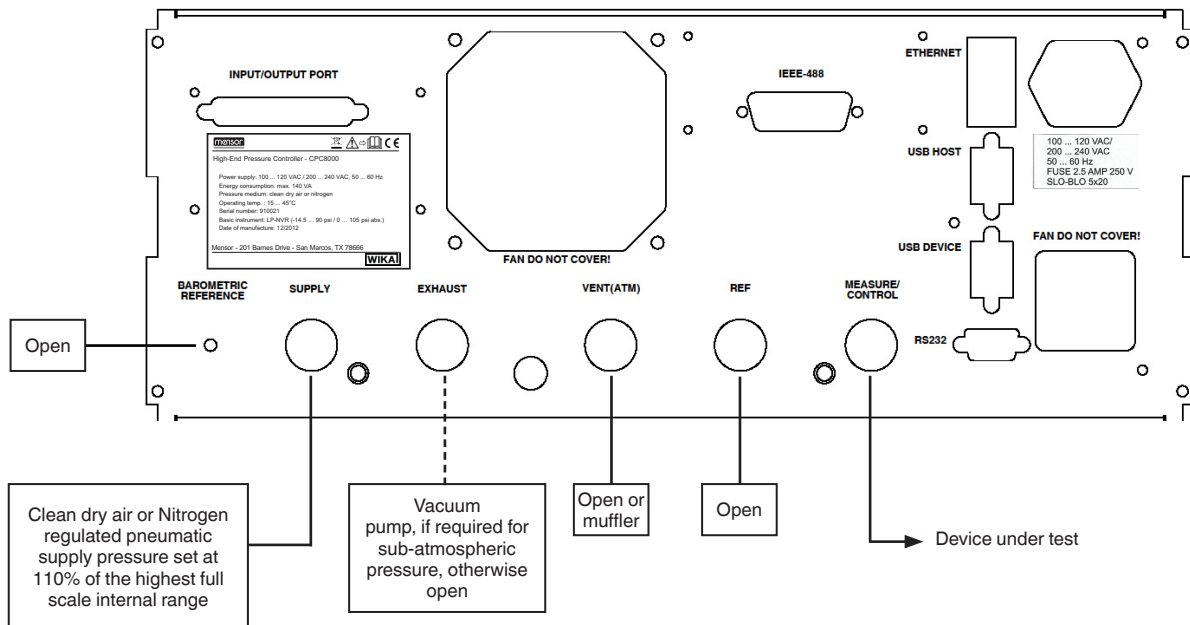

Figure 5.6 - Pneumatic Setup

5.7 Electrical & Communication Connections



WARNING! The electrical installation must be done according to the following instructions while observing the relevant regulations. It is to be performed by individuals familiar with the safety regulations for working on electrical connections.



Note: USB ports are compliant with the industry standard.

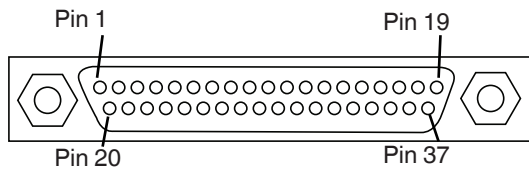

37-Pin Digital Input / Output

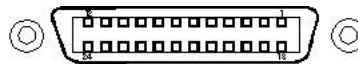

**IEEE-488.2
24-Pin IEEE-488 Socket**



**RS-232
9-Pin D-Sub Socket**

PIN	DESCRIPTION	19	OUTPUT4-NO
1	GROUND	20	INPUT5
2	INPUT1	21	INPUT6
3	INPUT2	22	GROUND
4	GROUND	23	INPUT7
5	INPUT3	24	INPUT8
6	INPUT4	25	GROUND
7	GROUND	26	OUTPUT5-COM
8	OUTPUT1-COM	27	OUTPUT5-NC
9	OUTPUT1-NC	28	OUTPUT5-NO
10	OUTPUT1-NO	29	OUTPUT6-COM
11	OUTPUT2-COM	30	OUTPUT6-NC
12	OUTPUT2-NC	31	OUTPUT6-NO
13	OUTPUT2-NO	32	OUTPUT7-COM
14	OUTPUT3-COM	33	OUTPUT7-NC
15	OUTPUT3-NC	34	OUTPUT7-NO
16	OUTPUT3-NO	35	OUTPUT8-COM
17	OUTPUT4-COM	36	OUTPUT8-NC
18	OUTPUT4-NC	37	OUTPUT8-NO

PIN	DESCRIPTION
1	D101
2	D102
3	D103
4	D104
5	EOI
6	DAV
7	NRFD
8	NDAC
9	IFC
10	SRQ
11	ATN
12	SHIELD
13	D105
14	D106
15	D107
16	D108
17	REN
18	GND
19	GND
20	GND
21	GND
22	GND
23	GND
24	GND

PIN	DESCRIPTION
1	DCD
2	TxD
3	RxD
4	DTR
5	GND
6	DSR
7	RTS
8	CTS
9	Ri

Note:
No Null Modem
Required

Figure 5.7 - Electrical Connections

5.7.1 Notices Regarding the Electrical Connections

5.7.1.1 Power Supply



WARNING! Before connecting the power supply, make sure that the power voltage agrees with the voltage specification of the CPC8000. Switch off the system before connecting the power.

The 3-pin power cable supplied is fitted with a ground lead. The system should only be operated from a 3-pin socket with the ground lead properly connected.

5.7.1.2 Interfaces



WARNING! The interface cables must not be longer than 3 meters and must be separate from cables with voltages greater than 60 volts.

5.7.1.3 Ethernet Interface

The Ethernet jack is a standard Ethernet interface used for remote communication.

5.7.1.4 USB Host Interface

The USB Host interface is a service port used to upgrade software and download information from the device. It has the same function as the USB Host port on the front of the CPC8000.

5.7.1.5 USB Device Interface

The USB Device jack is a standard USB Type B receptacle interface used for remote communication. The USB Driver can be downloaded at http://www.mensor.com/download_software_drivers_en_um.WIKA

5.7.1.6 RS-232 Interface

The RS-232 interface is a 9-pin D-Sub socket used for remote communication.

5.7.1.7 IEEE-488 Interface

The IEEE-488 interface is an IEEE-488 socket used for remote communication.

5.7.1.8 Input/Output Port



CAUTION! The Input/Output port has eight digital inputs that will accept either 3.3 VDC or 5 VDC signaling. Each input consumes about 8-10mA. If a voltage greater than 6VDC is applied to an input it will be permanently damaged.

The Input/Output port also has eight relay outputs. Both normally open and normally closed contacts are available for each output on the port. The contact ratings for the relays are as follows:

- Rated load (resistive): 0.5A @ 125VAC, 1A @ 24VDC
- Rated carry current: 2A
- Max. switching voltage: 125VAC, 60VDC
- Max. switching current: 1A
- Max. switching power: 62.5VA, 30W

The instrument can be set to respond to the digital inputs and to change the outputs based on certain conditions. [See section 7.5.2.5.8.](#)

6 Local Operation

6.1 General

This section describes the procedures for operating the CPC8000 from the front panel. Instructions for operating the instrument from an external computer are covered in [Section 8, Remote Operation](#). By following the procedures provided in these two Sections and in [Section 7, Setup](#), you can expect your CPC8000 to deliver maximum accuracy and dependability for many years of exceptional service.

When the instrument is powered on it will take about 30 seconds to boot up. At the end of the boot process the display screen similar to figure 6.1 will appear. This is the main operating screen. At this point the CPC8000 is ready for operation. However, for critical tests and measurements allow the unit to warm up for at least 15 minutes with power on to ensure rated accuracy.

Notice that the portion of the screen with a blue field covers about two-thirds of the total screen area. This area contains the pressure output reading, the setpoint, the active transducer range, units of measure, limits and a choice between the control modes: Measure, Control or Vent.

The sidebar to the right (black field) is used for entering data, adjusting environmental settings, defining parameters for remote operations, and making choices in the configuration. Several different sidebars can be accessed from the main screen to achieve different objectives.

This section of the manual will explain features of this main operating screen and the associated sidebars.

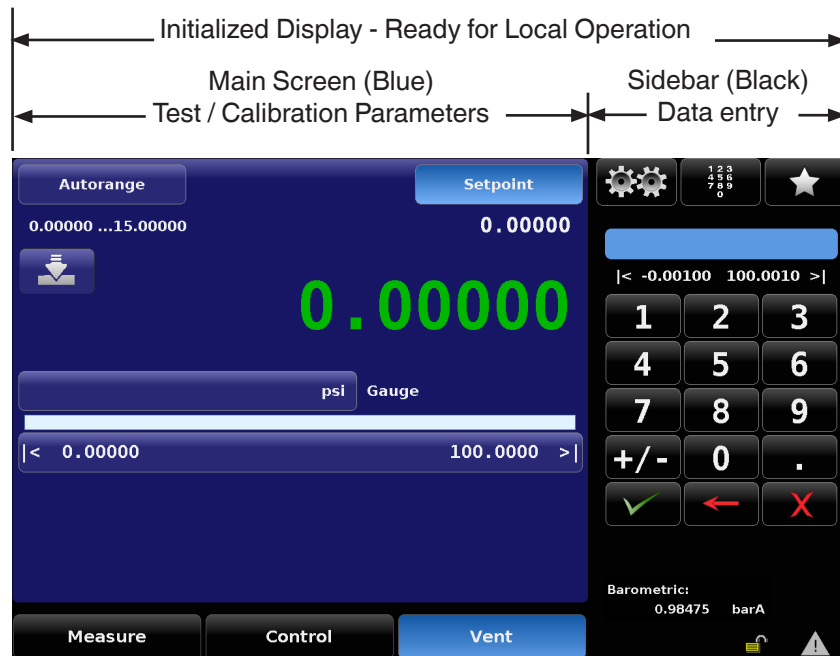

Figure 6.1 - Initialized Display

Beyond the main screen are a series of setup screens used to adjust parameters and conditions, such as performing calibrations, running programmed routines, operating from a remote computer, etc. All such setup screens are on black backgrounds, and have their own sidebars (also black) for choice menus and data entry. Explanations and instructions for using these setup screens are covered in [Section 7, Setup](#).

6.1.1 Buttons, Keys, Switches, Tabs, and other terms

Many of the words and symbols displayed on screen are active touch points, such that when touched or pressed something will change if it is an allowable action. In this manual these touch sensitive points are shown inside brackets such as [Setpoint], the button seen in the upper middle corner of the main screen (see figure 6.1.2). These touch points may be referred to as a button, a key (such as a number key), a toggle switch, a radio button also called a tab. Radio buttons and tabs are mutually exclusive buttons (if one in a group is chosen the others cannot be selected at the same time). Tabs are radio buttons shown along the bottom of most screens and they open other screens related to the activity named on the tab or indicate a selection associated with the active screen.

A touch point will respond with an audible “beep” as a signal of acceptance. A “blap” (error tone) sound is a signal that an illegal action was attempted, such as a number entry beyond the allowable range.

A word or symbol on a screen which does NOT respond to being touched or pressed is referred to in this manual as a label, window, monitor or an indicator. A label is merely a bit of information appropriate to the displayed activity, while a window is a variable, usually a numeric value. Also, some screens will display a line or more of text messages. Labels, windows, monitors, indicators and text are not touch sensitive.

6.1.2 Map of the Main Screen Features

Figure 6.1.2 is a map of the main screen features and reflects a CPC8000 without any of the extra display options. The map includes a title box for each screen feature and the section number of the explanatory text about the feature and its use.

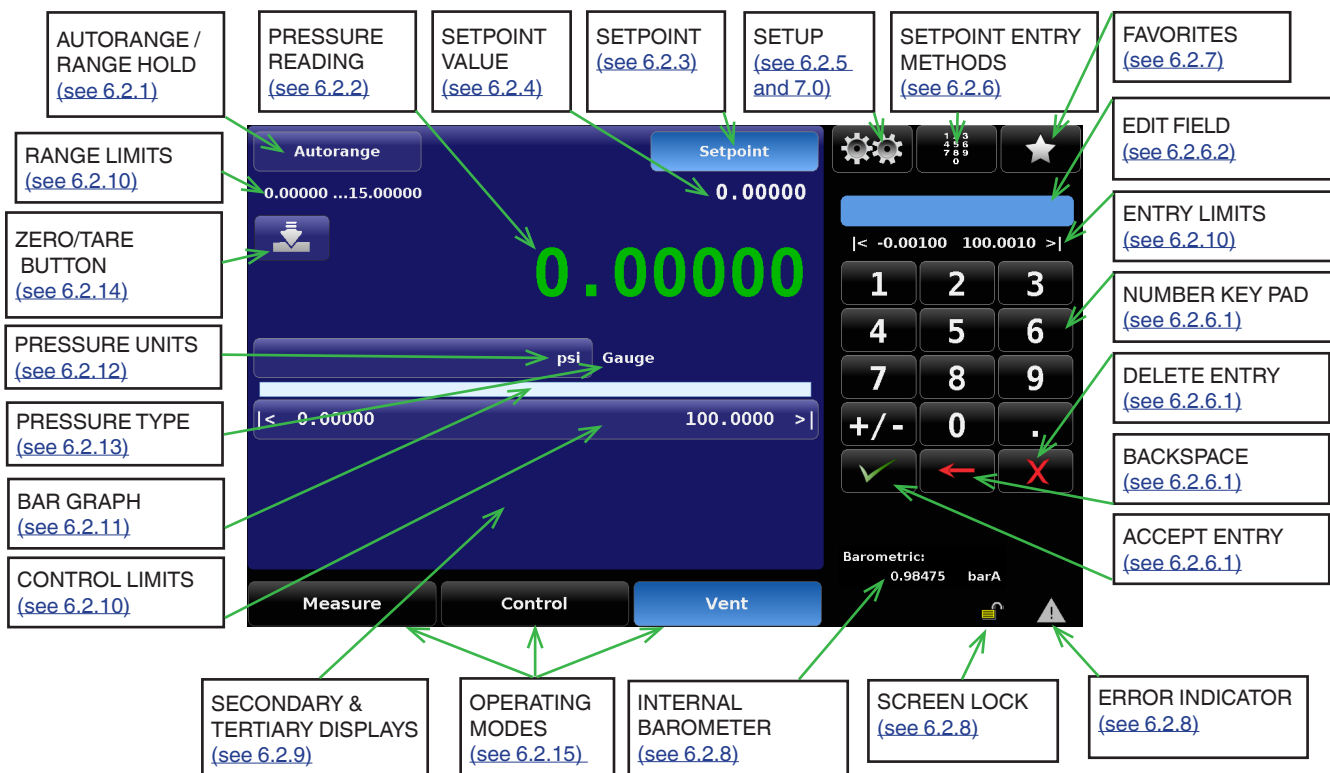

Figure 6.1.2 - Main Screen Map

6.2 Main Screen Features

The table below is a reference list of the features that appear on the main screen after power up.

Table 6.2 - Reference List of the Main Screen Features

Feature	
Autorange / Range Hold	see 6.2.1
Pressure Reading	see 6.2.2
Setpoint	see 6.2.3
Setpoint Value	see 6.2.4
Setup	see 6.2.5 & 7.0
Setpoint Entry Methods	see 6.2.6
Number Key pad	see 6.2.6.1
Delete Entry	see 6.2.6.1
Backspace	see 6.2.6.1
Accept Entry	see 6.2.6.1
Number Pad Step	see 6.2.6.2
Favorites	see 6.2.7 & 7.0
Screen Lock	see 6.2.8
Error Indicator	see 6.2.8
Secondary & Tertiary Displays	see 6.2.9
Limits (Range, Control, and Entry)	see 6.2.10
Bar Graph	see 6.2.11
Pressure Units	see 6.2.12
Pressure Type	see 6.2.13
Zero Button	see 6.2.14
Operating Modes	see 6.2.15

6.2.1 Autorange / Range Hold

The upper left corner of the main screen shows either [Autorange] or [Range Hold]. Although this is a two-state button, it is not a toggle switch. When [Autorange] is displayed the system will automatically select which of the available transducers (up to 3) to use at any time in a process for maximum accuracy. When [Range Hold] is showing the operator has assigned a specific transducer to be the lone, active transducer. In either case the active transducer window immediately below the button will identify, by range, which is the active transducer of the moment.

Press the [Autorange] / [Range Hold] button to cause the transducer assignment list to appear in the sidebar. This list will show a table of up to four choices, Autorange and one, two or three transducers, by range. The presently active range is highlighted. Touch either one of the listed ranges, or [Autorange] and that choice is immediately effective. If the CPC8000 is under pressure, only those transducers with ranges equal to or above the internal pressure are allowed to be chosen.



Figure 6.2.1 - [Aurorange] / [Range Hold]

6.2.2 Pressure Reading

The large, green number displayed in figure 6.2.1 is the pressure reading at the transducer connected to the Measure/Control port. It is green because the sensed pressure is within a user-defined stable window for a user-defined period of time. When the pressure is outside of the stable window, the number will be white. [See Section 7.3.2](#) for a detailed explanation and setup of the stable window.



Notice

The pressure reading will turn red if an external pressure is applied at the Measure/Control port that is 7% greater than the upper limit of the active transducer. Each transducer is supplied with a pressure release valve set for 10% over the calibrated pressure. Inherent internal safeguards are set to prevent overpressure.

6.2.3 Setpoint Button

The [Setpoint] button will activate a sidebar data entry method to accept a new setpoint value. The setpoint value is displayed in the window just below the [Setpoint] button on the main screen, [see Section 6.2.4](#). The setpoint value can also be adjusted incrementally in the sidebar by use of one of four setpoint entry methods:

- The numeric key pad
- A numeric step value assigned to the up [▲] and down [▼] arrow keys
- A digital step assigned to the up [▲] and down [▼] arrow keys
- A program

Procedures for making changes to the setpoint using these methods are covered in [Section 6.2.6, Setpoint Entry Methods](#).

6.2.4 Setpoint Value

The setpoint value window is located immediately under the [Setpoint] button. It displays the current pressure setpoint (target value for the output pressure provided by the internal regulator when in Control mode). To edit the setpoint value, first touch the [Setpoint] button. This will activate the system for setpoint changes. The sidebar will display the default number key pad or a pre-chosen setpoint entry method. To

change the setpoint value use one of these methods described in [Section 6.2.6](#).



Figure 6.2.4 - Output Pressure Setpoint

6.2.5 Setup



Press Setup [] in the sidebar to move out of the main screen and into the setup screens. Notice the bottom row of six subject tabs and the arrow on the left end of the row (see figure 6.2.5). Each tab will bring up a screen relevant to the subject in the tab title.



Figure 6.2.5 – Setup Screen Tabs

After regaining the main screen, the last visited setup screen will return if Setup [] is pressed again. Operational information for the setup screens and their associated sidebars is contained in [Section 7, Setup](#).

6.2.6 Setpoint Entry Methods

Pressing the key pad icon [] in the middle of the top row will display the four line menu as shown below.

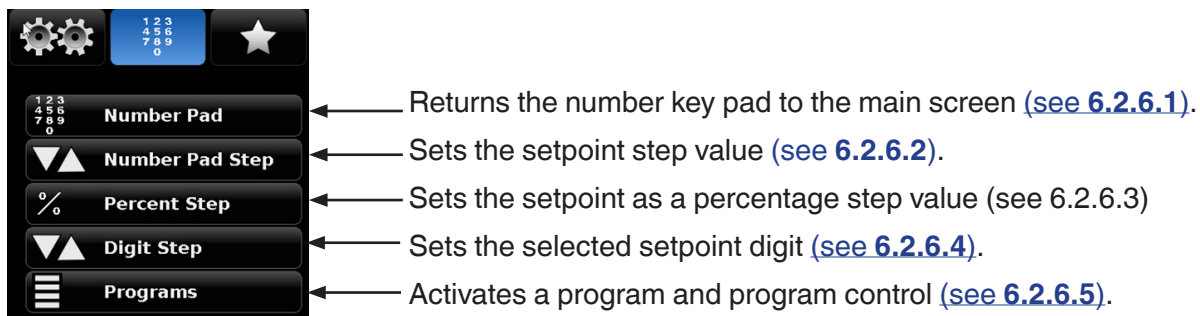
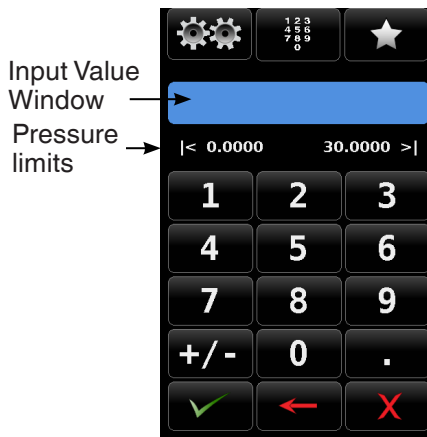



Figure 6.2.6 - Setpoint Entry Methods

6.2.6.1 Number Key Pad



The [Number Pad] button provides 10 digits for numeric entry, plus the decimal point and a sign key. The sign key [+/-] will toggle between positive and negative values. Each stroke on the key pad will echo in the blue input value window above the pad. A change between plus and minus values [+/-] can be entered at any time during the string entry. Pressing the Enter [] key will accept the value and it will become the new Setpoint.

If the input window holds an illegal value when the Enter [] is pressed the system will respond with a an error tone and the entry will turn red. When that happens determine the cause of the rejection, delete the entry, and then enter a valid number.

Pressure limits are shown above the key pad and indicate the allowable range for entry. This is either the range of the active transducer, the full range of the instrument (when in Autorange mode) or the range limits set in the setup controls limits menu ([see Section 7.3.1 Max and Minimum Limits](#)).

There are three action keys below the number keys that operate on the numbers displayed in the input value window:



Press the Enter [] key to accept the value showing in the number echo window into the system for immediate use.



Press the Backspace [] key to erase the last number entered in the string. Multiple presses will back out multiple digits.







Press the Delete [] key to delete the entire value showing in the echo window ([see Section 6.2.8](#)) to start anew, or to abort.

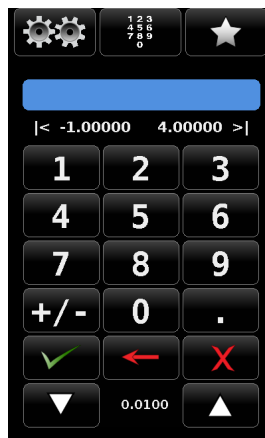

6.2.6.2 Number Pad / Step

The “Number Pad Step” key pad functions in two different ways:



(1) A setpoint can be entered in the same way as the Number Key Pad above: key in the number and press Enter [], that number is then immediately accepted into the setpoint value.

(2) Key in a number and press the Step Up [] or the Step Down [] key, (without pressing the Enter [] key), that number will be used to decrease or increase the existing setpoint value.

Subsequent touches of the Step Up or Step Down key will continue to increase or decrease the setpoint by this step value until a new value is keyed in followed by a key press of the Step Up [] or the Step Down [] key. If the Enter [] key is pressed the newly entered value will register as a new setpoint value on the main screen rather than a step value.

6.2.6.3 Percentage Step



In the digital Percentage Step Mode the user can select a setpoint value as a percentage of the pressure range of device under test. The user can choose between various percentage values by clicking on the desired button.

The setpoint is instantly changed to the selected percentage value of DUT. The user can also configure the minimum and maximum pressure value of the DUT by clicking the button displaying pressure range. This would take the user to the Step Settings screen where the DUT range, overrange and the percentage points can be set. The percentage points can be determined by pre-defined presets or customized by the user.

The Up [▲] or Down [▼] key at the bottom of the is associated with the digital step entry method (see Section 6.2.6.4). The setpoint is increased or decreased by one digit.

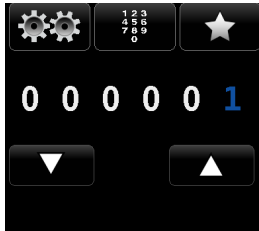

Figure 6.2.6.3-A - Percentage Entry



Figure 6.2.6.3-B - Step Settings

6.2.6.4 Digital Step



In the digital Step Data Entry Mode there is initially a string of five white zeros (0) and one blue numeral one (1) across the top as shown in the figure to the left. Any one of these zeros can be converted to a blue 1 by touching it. Slide a finger across the zeros to demonstrate this action. Using this feature each digit of the setpoint can be increased or decreased by one digit at a time by activating the corresponding digit with a blue 1 and pressing the Up [▲] or Down [▼] key.

For example, in the screen below the setpoint is at 50.0000, and the operator would like to change this to 51.0000, 52.0000, 53.0000.... and so on. He simply has to touch the digit in the Digital Step that corresponds to the “ones” digit in the Setpoint, thereby activating that digit and then press the Up [▲] key to increase that digit.



Figure 6.2.6.4 - Digital Step Screen

If the resolution of the instrument were set to 4 then the right most digit in the Digital Step screen would correspond to the least significant digit of the setpoint and the left two digits in the Digital Step screen would not be used.

6.2.6.5 Program Data Entry







The Program Data entry method provides an automated way to interact with the CPC8000. Many setting or process that can be entered manually can be programmed into the unit and saved and used in the Program portion of the data entry screen. Programs are prepared and stored in the Setup [] / [Application] / [Program] screen. [See Section 7.5.2.5.6 Programs](#) for details on how to create, edit and save programs.



Figure 6.2.6.5 - Program Data Entry Screen

After a program has been chosen by pressing the program selection button, press the Play [] button to start the program. The Pause [] button can be pressed at any time to stop the program at the current step, then the Play [] can be pressed to resume. To move forward or backwards in the program press the Back [] button or the Forward [] button. The Stop [] button will stop the program and place the CPC8000 in Measure mode.

6.2.7 Favorites

The Favorites [★] button provides a place to store s that are frequently used and also contains several prepackaged programs that are used to perform a leak test and a single point zero of each transducer. Programs that are displayed in the Favorites menu are chosen in the Setup [⚙️] / [Applications] / [Favorites] screen. See Section 7.5.2.5.7 to select displayed favorites.



Figure 6.2.7 - Favorites

6.2.8 Status Bar

Located below the number pad is a status bar consisting of two icons.

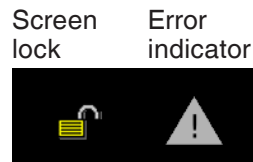

Figure 6.2.8 - Status Bar



Screen lock: This icon indicated the status of the touchscreen: locked or unlocked for manual interaction.



Error indicator: A yellow error indicator triangle indicates that there is an error recorded in the error register. Pressing the yellow error indicator will open the Setup [⚙️] / [Applications] / [Troubleshoot] screen where errors can be viewed. See Section 7.5.2.5.9, [Troubleshoot](#) for more information. The error register will clear itself when it is viewed, however, this does not correct the error. A corrective action still must be specifically addressed.

6.2.9 Secondary and Tertiary Display

There are two data lines available in the lower portion of the main screen reserved for the operator to display two items from a list of choices. The first line is called the secondary display, and the next line is the tertiary display. The list of choices are identical for both lines. The choices are available for selection in the Setup [] / [General] [Secondary / Tertiary Display] screen shown in figure 6.2.9b below. An explanation on how to setup and choose options for this area is given in [Section 7.1.2, Secondary and Tertiary Display](#).



Figure 6.2.9a - Secondary and Tertiary Displays

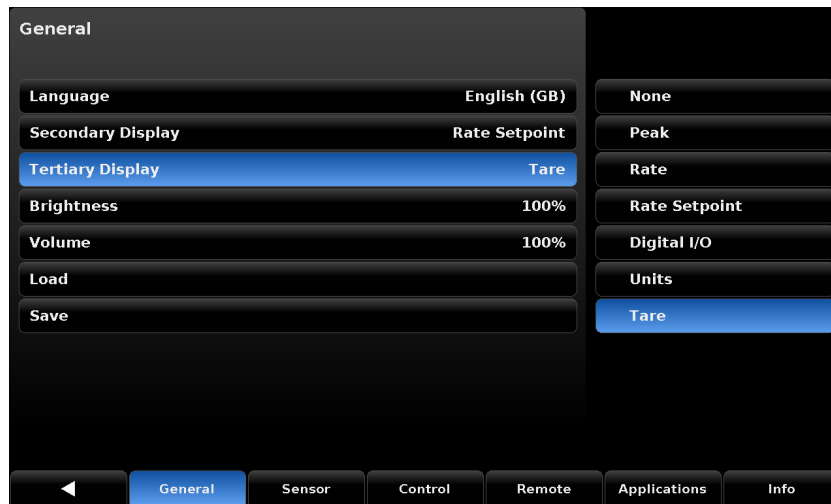

Figure 6.2.9b - Screen of Display Choices

6.2.10 Limits

Limits are shown in three places in the main screen. The “Range Limits”, “Control Limits” and “Entry Limits” shown in figure 6.2.10 below can show two different readings depending on settings. The “Range Limits” shows the limits of the range selected in Range Hold mode or the limits of the active transducer in Autorange mode. The “Control Limits” are the limits entered into the Setup [] / [Control] [Maximum Limits]/[Minimum Limits] screen (see Section 7.3.1). The “Control Limits” limit the value that can be entered as a setpoint. The “Entry limits” are equal to the lessor of the Control Limits or the Range Limits (when in Range Hold mode).



Figure 6.2.10 - Limits

6.2.11 Bar Graph

The bar graph is always active and reports in real time the pressure at the Measure/Control port. This provides a visual comparison between the actual pressure and the user selected control limits.



Figure 6.2.11 - Bar Graph

6.2.12 Pressure Units

The pressure units that the CPC8000 is currently using are displayed very near the center of the main screen, just above the bar graph. To change pressure units, touch the current unit symbol to display a page of the units menu in the sidebar. There are forty pre-defined pressure units listed in seven menu pages so it may be necessary to scroll through several pages to locate the desired units. On the screen, touch either the up [▲] or down [▼] symbol to scroll to the next units page. Continue to scroll until the desired pressure units are found; then touch that line in the menu to activate the new units.

Touching the [▼] & [▲] symbols will scroll continuously through each set of units and start over at the beginning.

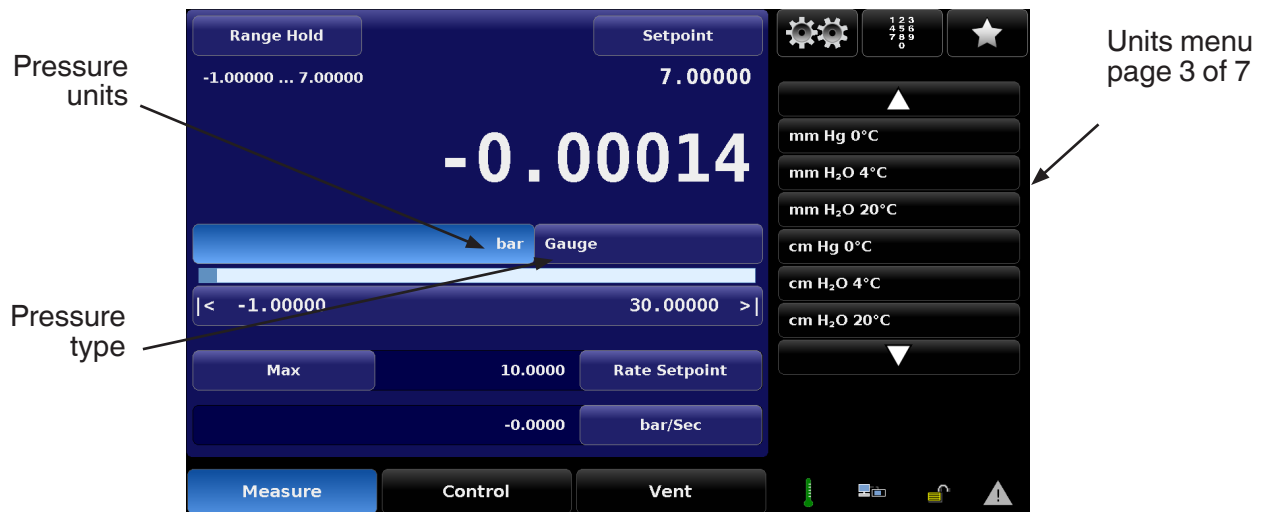

Figure 6.2.12 - Pressure Units

There are several tables of conversion factors for pressure units in [Section 11, Appendix](#). The PSI table includes the factors for conversion to or from PSI to all of the other available units. Another table uses Bar as the basis for conversion factors to or from most of the more common alternative units.

6.2.13 Pressure Type

Pressure type (see figure 6.2.12) is a label of either [Gauge] or [Absolute] according to what type of transducer is in the CPC8000. The exception is that this feature is an active switch which toggles between [Gauge] and [Absolute] if there is a barometer option included in the system. The barometer is used to emulate gauge pressure when the native transducers are absolute and absolute when the native transducers are gauge. (See [Section 9.3](#) for details of the barometric reference transducer option).

6.2.14 Zero/Tare Button

The Zero Cal Button [], appears in the main screen, if the Zero Calibration function has been chosen in the Setup screen. An explanation on how to setup and choose the Zero button is given in [Section 7.1.2, Calibration Function](#). If the instrument is measuring absolute pressure, a barometer is required to be used as the reference standard to perform the zero. When the Zero Cal Button is pressed, a keyboard will appear to allow a single point calibration. If the instrument is measuring gauge pressure, pressing the button will set the current reading to zero. If the instrument is in emulation mode (absolute or gauge) then the value will not be saved to the transducer but only as a temporary adjustment while in emulation mode. After exiting the emulation mode or after a power cycle, the temporary adjustment will be cleared. The zero adjustment for an instrument not in emulation mode will be saved to the transducer as if single point calibration had been performed.

Figure 6.2.14-A shows an instrument with gauge transducers with Zero Button enabled. The right side of the screen displays the status of the zeroing process. The process can be aborted at any time by pressing the Abort Button []. Figure 6.2.14-B shows an instrument with absolute transducers with Zero Button enabled.



Figure 6.2.14-A Zero Button in Gauge



Figure 6.2.14-B Zero Button in Absolute

The Tare Button [**T**] will be displayed whenever “Tare” is active. The button will be cautionary yellow to indicate the pressure reading is affecting by the offset.



Figure 6.2.14-C Tare Button active

6.2.15 Operating Modes

The CPC8000 has three operating modes: Measure, Control, and Vent. After the system has been switched on, and after a subsequent short self-test, the instrument will automatically be placed in Measure mode. The operator can switch from one mode to another by using the mode selection keys located just below the front panel display.



Notice

When switching from Control mode to Measure mode, the system will not be vented and the last applied pressure will be locked in the system by means of a solenoid valve.



Figure 6.2.15 - Operating Modes

Measure Mode:	Control Mode:	Vent Mode:
<p>In Measure mode the CPC8000 acts like a precision pressure measuring instrument and measures the pressure applied at the Measure/Control port.</p> <p>If the Control mode was the last used mode before switching into Measure mode, the last controlled pressure is held in the test assembly.</p> <p><u>See Section 6.2.15.1, Measure Mode</u></p>	<p>In Control mode the CPC8000 provides a controlled pressure at the Measure/Control port equal to the setpoint value.</p> <p><u>See Section 6.2.15.2, Control Mode</u></p>	<p>The Vent function will vent the system to the atmosphere, including the test assembly connected to the Measure/Control port.</p> <p><u>See Section 6.2.15.3, Vent Mode</u></p>

6.2.15.1 Measure Mode

In Measure mode, the instrument measures the pressure at the transducer connected to the Measure/Control port. The Measure mode is activated by pressing the [Measure] button.

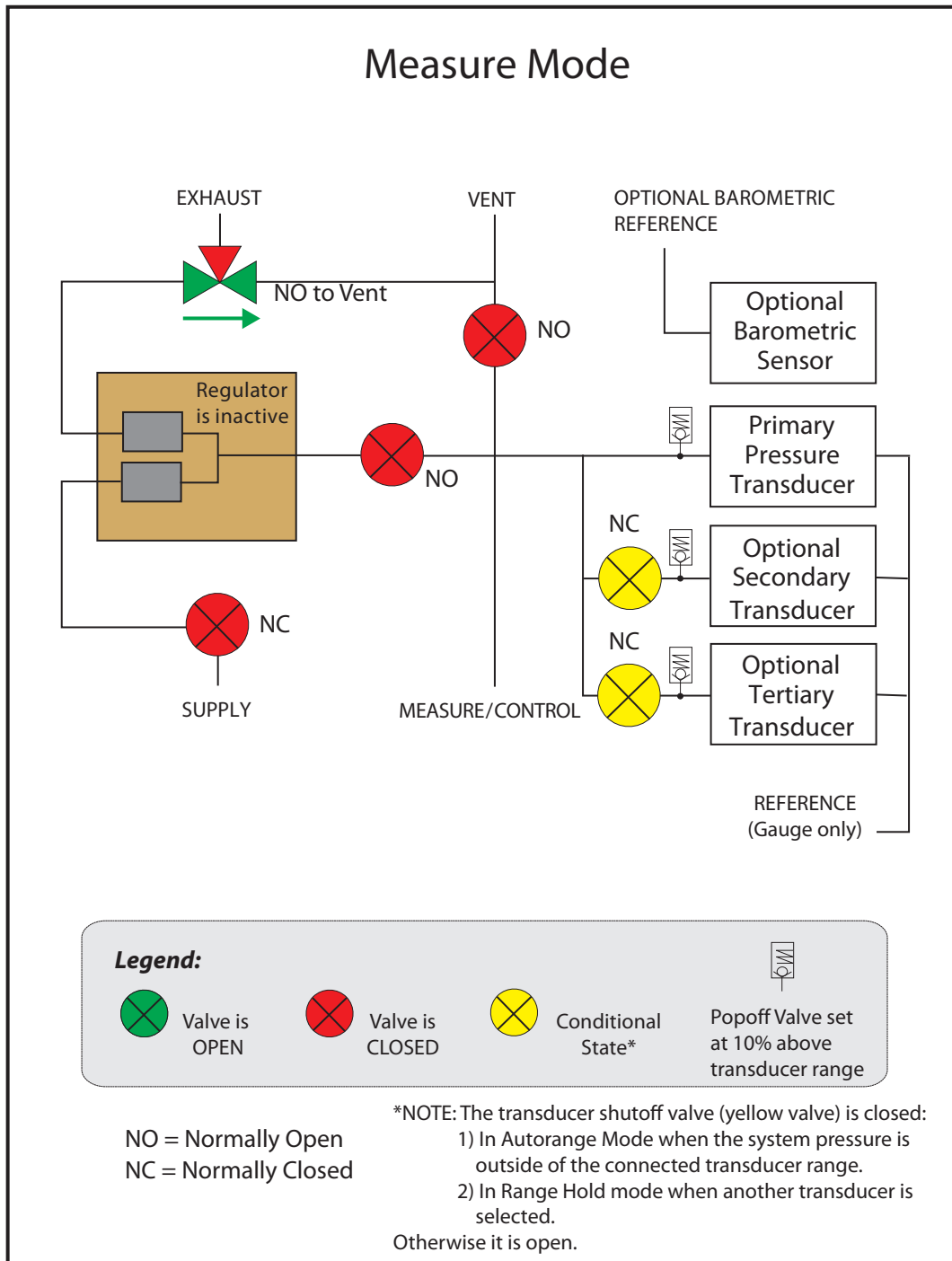

Figure 6.2.15.1a - Measure Mode

If the pressure is beyond the permissible measurement range, the pressure reading is displayed in red instead of white figures. As soon as a pressure of approximately 110% full scale is reached, an integrated safety relief valve opens and releases the pressure into the inside of the instrument. The regulator is not active in Measure mode.

The setpoint value can be input while in the Measure mode then Control mode can be activated by pressing the [Control] key and the CPC8000 will start to control to the setpoint value.

The figure below shows the state of the isolation valves in Measure mode.



6.2.15.1b - Isolation Valves in Measure Mode

6.2.15.2 Control Mode

In Control mode, the instrument provides a precise pressure output at the Test port. The indication of the current pressure value will turn green when the setpoint has been reached and the stable window settings have been satisfied.

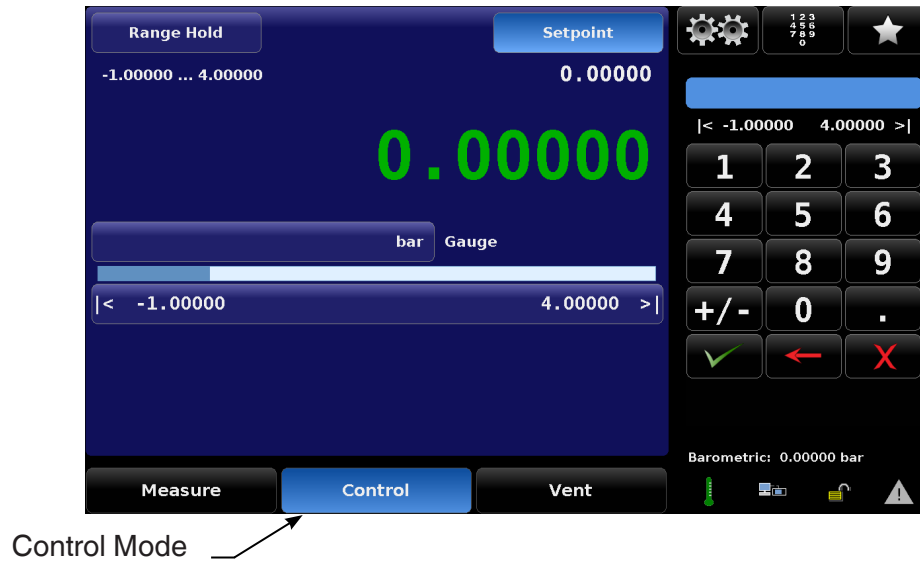





Figure 6.2.14.2a - Control Mode

The Control mode is activated by pressing the [Control] button in the main menu. The Control mode can be accessed from the Measure mode or the Vent Mode by pressing the [Control] button. In the Control mode the CPC8000 acts as a precision pressure controller and provides a stable pressure output at the Measure/Control port.

In order to ensure that the controller is correctly configured for the task it is to perform, the following measures must be taken and the respective parameters must be set in the Setup [] menu.

- In order to control pressures close to or below atmospheric pressure, a vacuum pump should be connected to the Exhaust port.
- The control speed can be set in the Setup [] / [Control] / [Rate setpoint] screen. The Control rate can be set between 0.001% of range/sec to 10% of range/sec.
- Control limits can be set in the Setup [] / [Control] / [...limits] screen.

The figure below shows the state of the isolation valves in Control mode. Notice that the regulator is active in the Control mode.

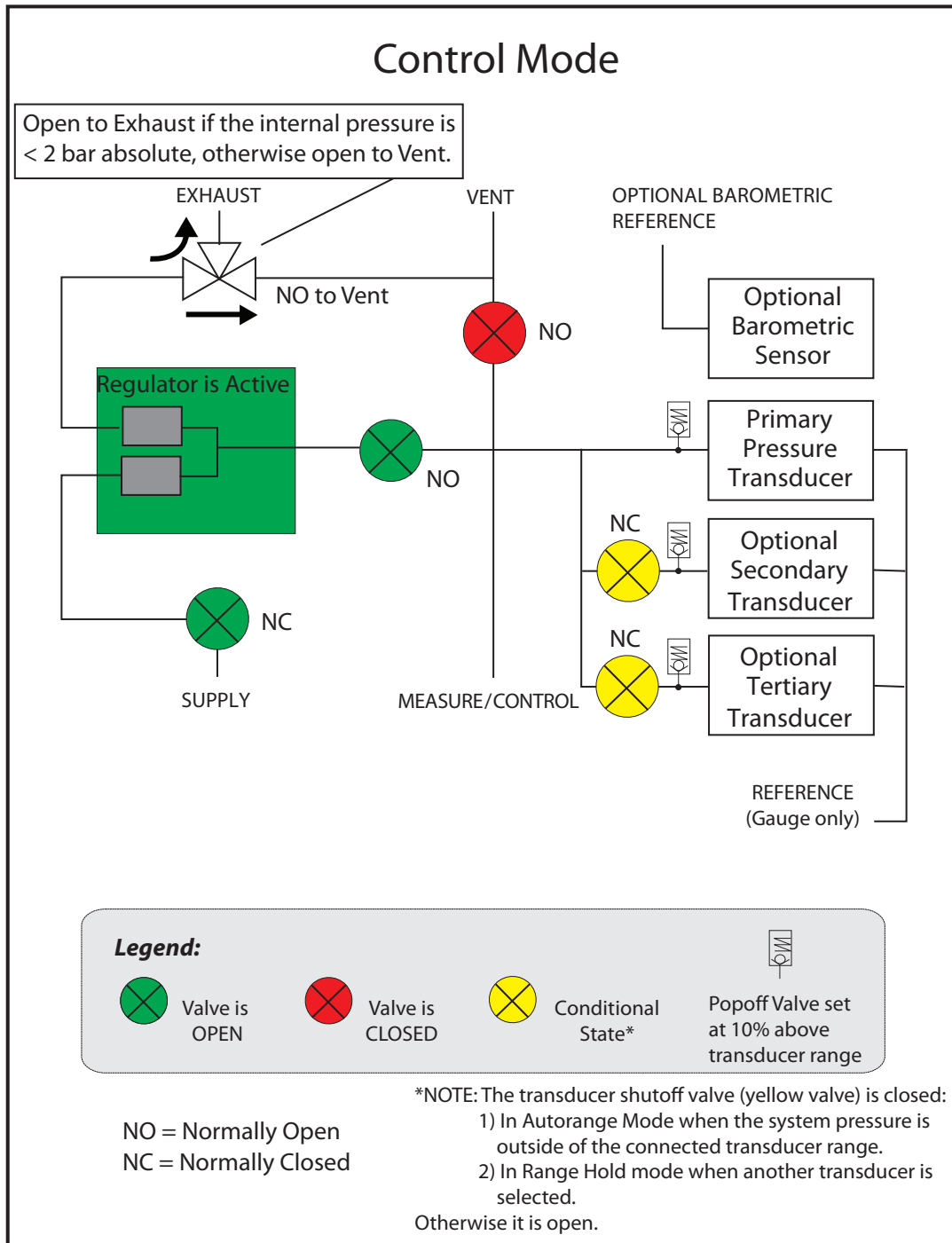

Figure 6.2.15.2b - Isolation Valves in Control Mode

6.2.15.3 Vent Mode

Vent mode vents the pneumatic system and shuts off the supply. The Vent mode can be activated from the Measure or Control mode by pressing the [Vent] button. Internal system pressure will be vented through the Vent port.



Vent Mode

Figure 6.2.15.3a - Vent Mode



Warning

WARNING! Venting will cause a sudden loss of pressure in the system and the plumbing connected to the measure control port. Care must be taken that the device under test is not damaged during venting.



Warning

WARNING! In some cases venting will exhaust high velocity air from the vent port. Personnel and sensitive equipment should not be in close proximity to the vent port during venting.



Warning

WARNING! In some cases venting high pressure will cause a loud sound. Personnel should wear a hearing protection device when working with high pressures.

The figure below shows the state of the isolation valves in Vent mode.

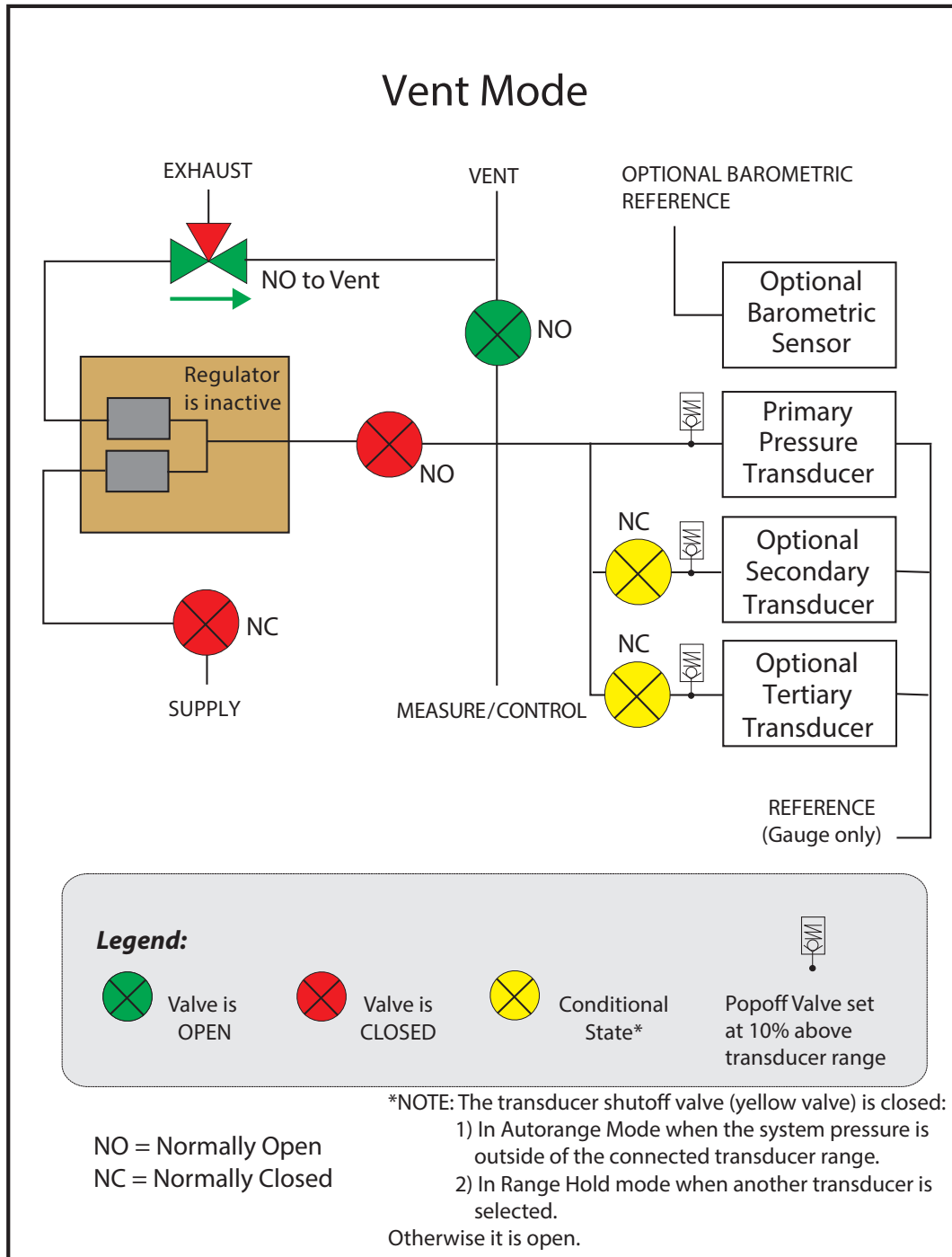

Figure 6.2.15.3b - Illustration Showing Isolation Valves in Vent Mode

6.2.15.4 State of the Isolation Valves when the CPC8000 is off

When the CPC8000 is turned off the valves revert to their normal state: either Normally Open (NO) or Normally Closed (NC) as indicated above.

7 Setup

After the instrument has been powered on and the main screen is displayed, press the Setup [] button on the sidebar to setup parameters or make changes to the instrument settings.



Figure 7a - Location of the Setup [] button on the main screen

The following is a menu tree that shows the general layout of the setup menus. The bullet points in blue represent screens that require the first level password to view; those in red require a second level password to view.

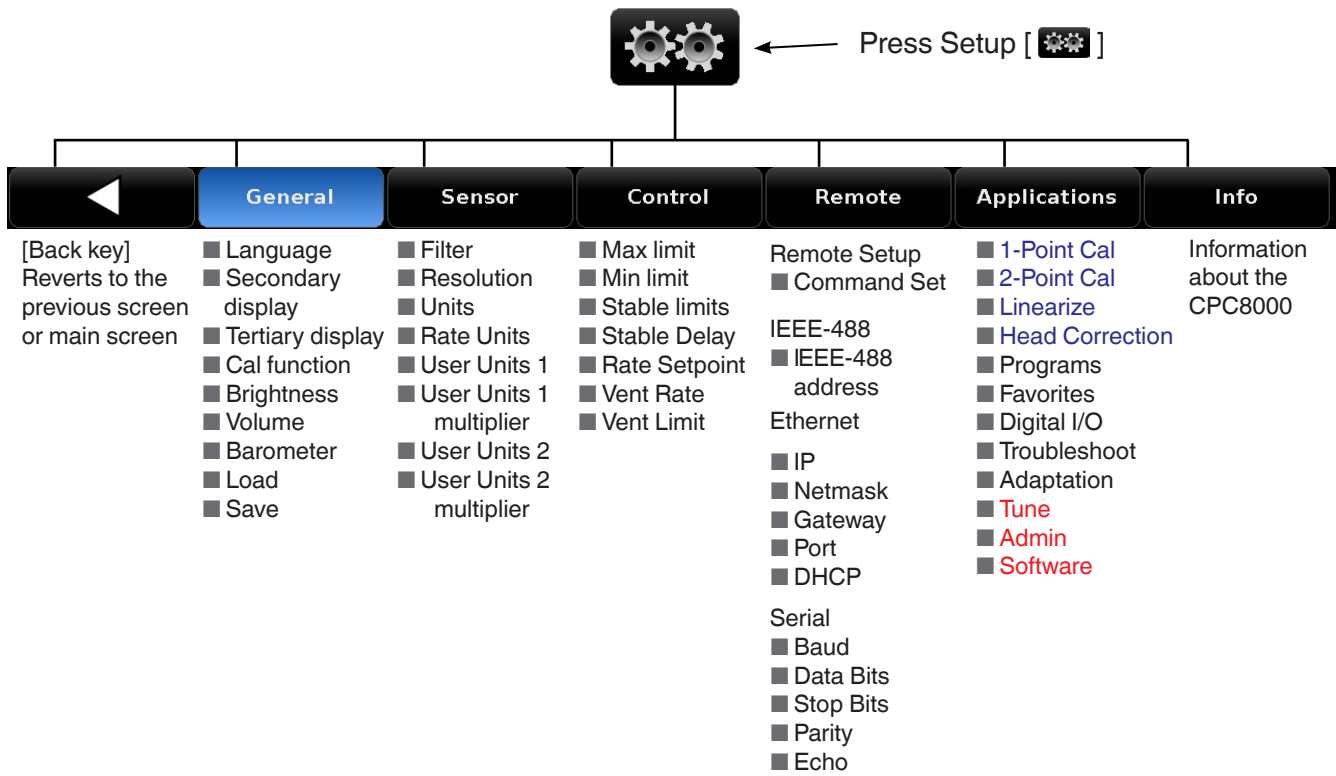



Figure 7b - Menu Tree of the Setup Menus

7.1 General Tab

7.1.1 Language

The languages that are available in the CPC8000 are shown by pressing Setup [], then press the [General] tab, and then the [Language] button. Note that the active language is indicated on the right side of the [Language] button. When the [Language] button is pressed, the sidebar will show the languages that are available. Pressing the desired language on the sidebar will make that language active on every screen in the CPC8000.

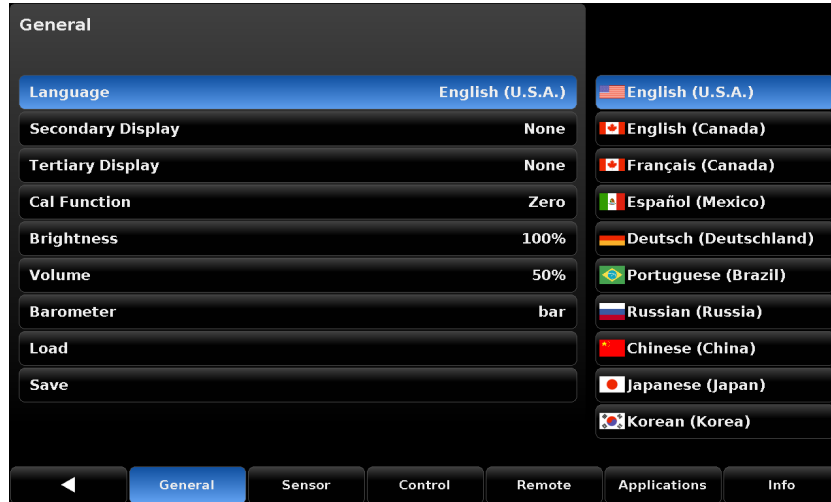

Figure 7.1.1 - Language

7.1.2 Secondary and Tertiary Display

The Secondary and Tertiary display areas provide a place to indicate extra data that may be desired during testing or calibration. In the [General] tab, there is a selection button labeled [Secondary Display] and one labeled [Tertiary Display]. Clicking either of these will change to a sidebar to indicate the choices that are available to each of these display areas. Pressing any one of these choices will make that choice active in its respective display area on the main menu.

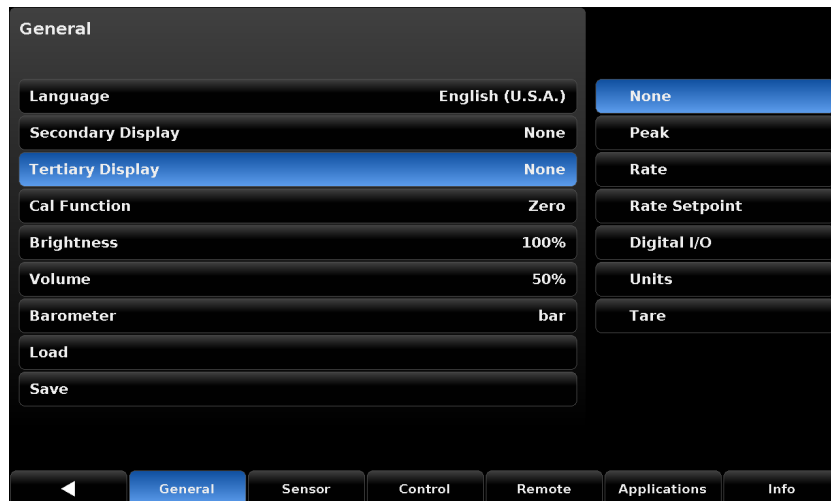

Figure 7.1.2 - Secondary and Tertiary display

7.1.3 Calibration Function

The [Cal Function] button within the [General] tab provides a selection to enable the zero button on the main screen. Clicking the [Cal Function] button would present a choice of Zero, Tare or None on the sidebar. Selecting the [Zero] option would enable the zero button and selecting None would disable it. Figure 7.1.3-B shows selecting tare option will match auxillary display. Figure 7.1.3-C Shows Tare funtion disabled when a percent of range units are active.

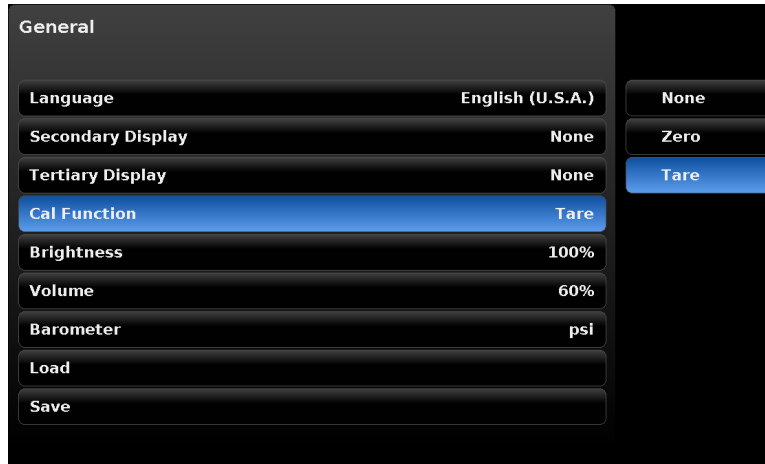

Figure 7.1.3-A - Cal Function

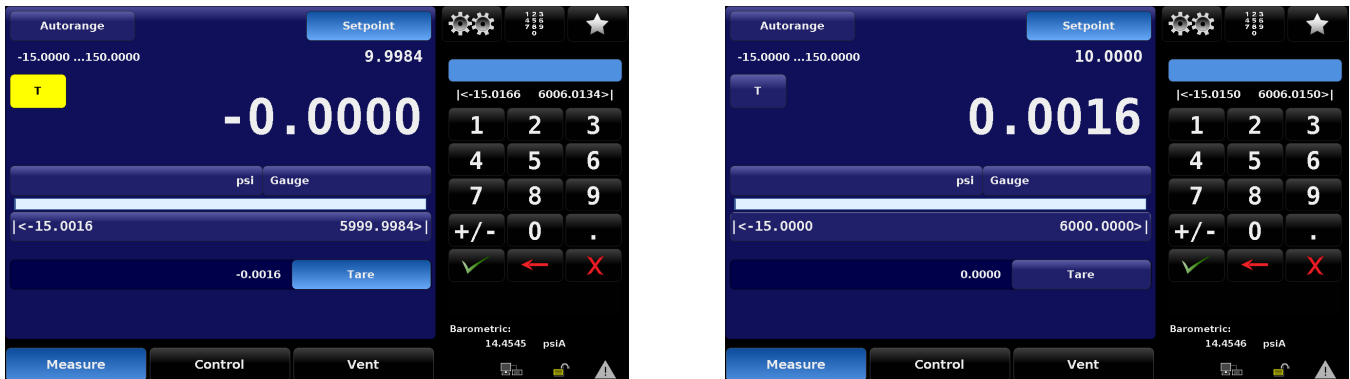



Figure 7.1.3-B Tare Button Auxillary Display



Figure 7.1.3-C Tare Function Disabled

7.1.4 Brightness

The [Brightness] button within the [General] tab of the Setup [] menu provides a place to set the global brightness of the instrument's screens. When the [Brightness] button is chosen a graduated brightness "bar graph" will appear in the sidebar. This is a sliding scale of brightness and can be changed by sliding ones finger up and down on the bar graph or simply touching an area on the graph that corresponds to a brightness level.

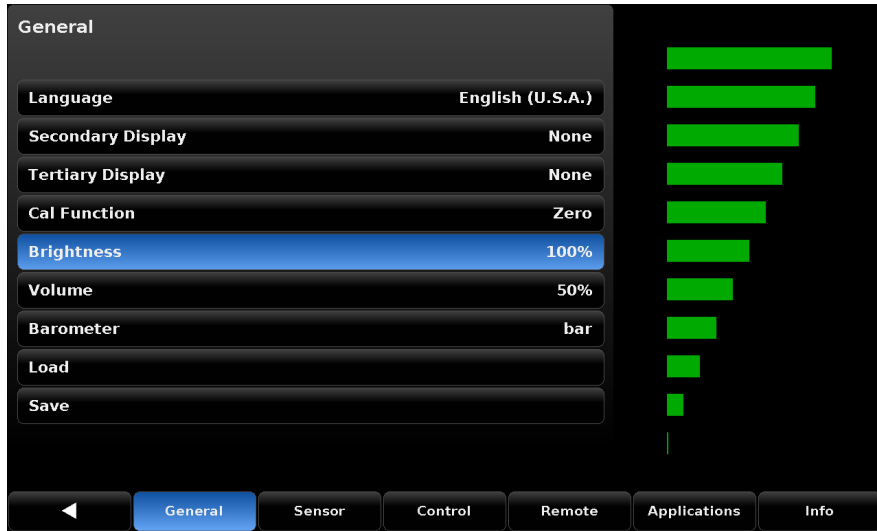



Figure 7.1.4 - Brightness

7.1.5 Volume

The [Volume] button within the [General] tab of the Setup [] menu provides a place to set the global volume for the instrument's auditory feedback sounds. When the [Volume] button is chosen a graduated volume "bar graph" will appear in the sidebar. This shows the relative volumes available and can be changed by sliding ones finger up and down on the bar graph or simply touching an area on the graph that corresponds to the desired volume level.

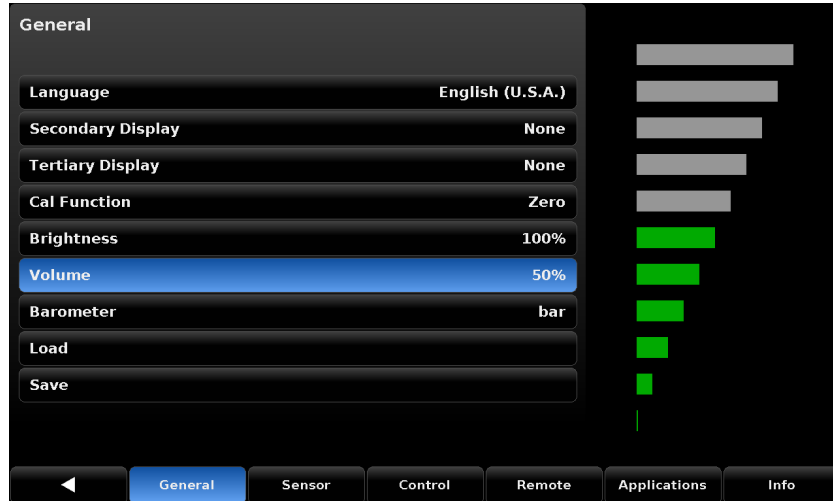

Figure 7.1.5 - Volume

7.1.6 Barometer (Units)

The Barometer button provides selection of units from a list of English or Metric units presented on the right side of the screen. Any of these units can be chosen from this list for the barometric readout. The barometric pressure readout can be seen on the bottom right of the Main Screen.

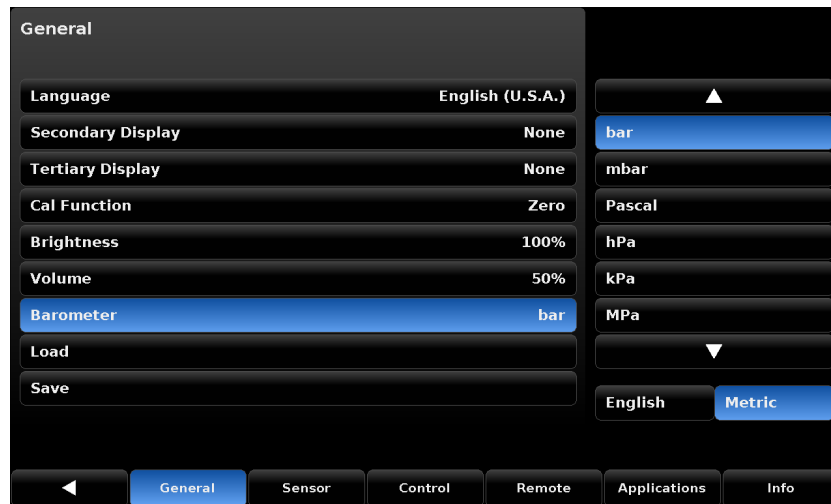

Figure 7.1.6 Barometer (units)

7.1.7 Load (Configuration)

Each configuration can store a complete set of parameters and settings. Configurations can be recalled (loaded) as needed. Configurations contain settings for the following set of parameters:

Table 7.1.7 - Configuration Parameters

Lower limit	Upper limit	Setpoint	Step	Rate setpoint	Rate step
Stable window	Stable delay	Rate stable window	Rate stable delay	Vent rate	Emulation mode (gauge/abs)
Filter	Resolution	Units	Rate units	Secondary units	Brightness
Volume					

Explanation on how to set up each configuration can be found below in Section 7.1.8

The [Load] button within the [General] tab of the Setup [⚙️] menu, shown in figure 7.1.7, provides a place to choose a saved configuration. When the [Load] button is chosen a choice of several configurations are displayed on the sidebar. When one configuration is chosen its saved parameters and settings will be active in the instrument.

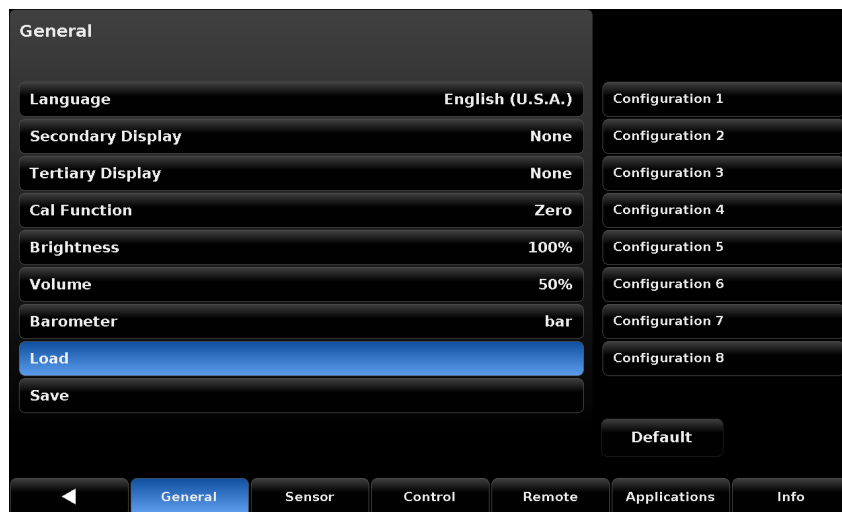

Figure 7.1.7 - Load (configuration)

7.1.8 Save (Configuration)

The [Save] button within the [General] tab of the Setup [⚙️] menu, shown in figure 7.1.7, provides a place to save configurations for the instrument. When the [Save] button is chosen a list of configuration numbers are displayed on the sidebar. When a configuration number is chosen and the check mark [✓] is pressed the current instrument settings will be saved within this configuration number. Instrument settings that are saved in configuration settings are given in table 7.1.7.

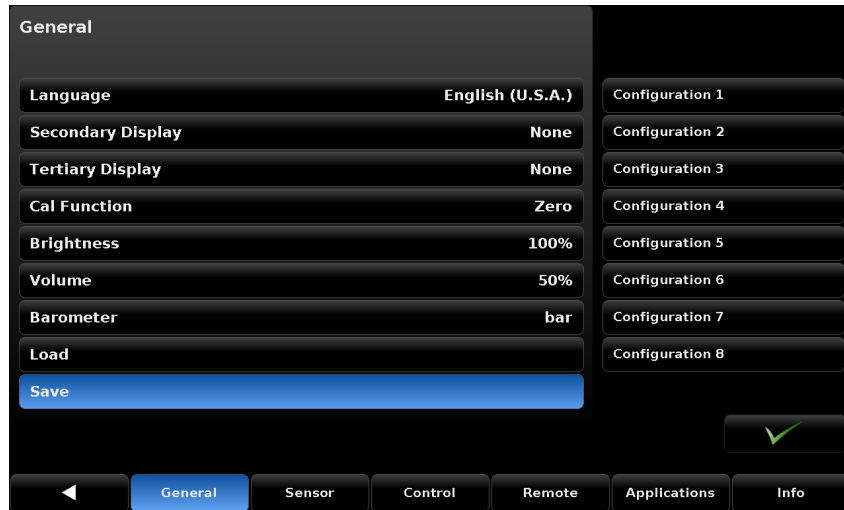



Figure 7.1.8 - Save (configuration)

Configurations can be used to save time in setting up parameters for specific calibration needs. For example, there may be a requirement to calibrate a 100 psi transducer, and an upper limit of 105 psi cannot be exceeded and the rate of pressure change cannot exceed 5 psi per second. These parameters can be set and assigned (saved) in one of the configuration numbers and recalled (loaded) before this test is run.

7.2 Sensor Tab

Within the [Sensor] tab of the Setup [] menu are parameters that are associated with all of the installed pressure transducers. Settings chosen here will affect the indicated and remote output of the instrument's pressure reading.

7.2.1 Sensor Filter

In the [Sensor] tab in the Setup [] menu there is a button labeled [Filter]. The right side of the [Filter] button shows the current filter setting. The sensor filter acts on the output pressure indicated on the instrument, filtering out small pneumatic and electrical variations in the pressure transducer output. This is done by mathematically smoothing the output reading using a low pass filter on the electrical output of the pressure transducer. The filter can be set to Off, Low, Normal or High simply by pressing the associated button on the right side of the menu.

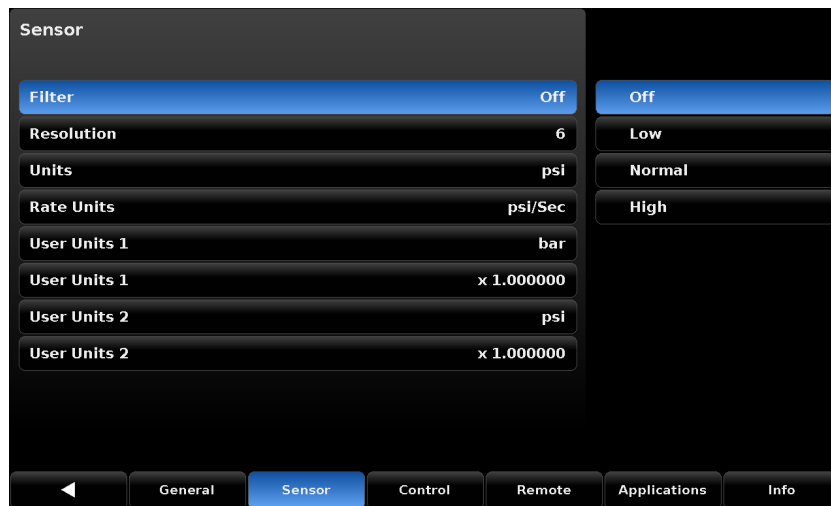



Figure 7.2.1 - Filter

7.2.2 Resolution (Display Digits)

In the [Sensor] tab in the Setup [] menu there is a button labeled [Resolution]. The right side of the [Resolution] button shows the current resolution setting with a blue button. The display resolution for the pressure output can be chosen from this side bar selection menu. The resolution is the number of digits that will be shown in the pressure indication within all screens of the instrument. The user can change the resolution to 4,5 or 6 with CPR8000 transducers and to 4,5,6 or 7 with CPR8800 transducers

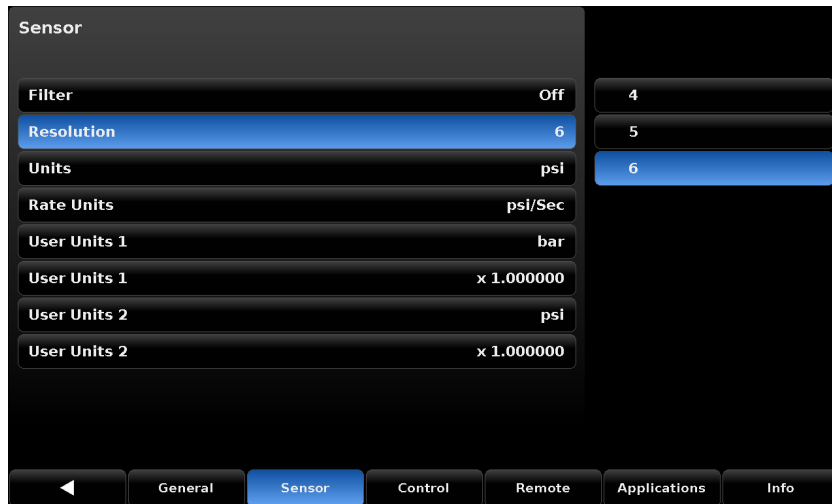





Figure 7.2.2 - Resolution

7.2.3 Units

In the Setup []/[Sensor] tab there is a button labeled [Units]. When selected, the side bar will display a set of 6 selectable units and an Up [] and a Down [] arrow used to scroll through a set of 40 different units and 2 user defined units. Selecting any of these units will change the unit of measure for the pressure sensed by all of the internal pressure transducers and will also apply these units to reading taken remotely. This same selection of units can be accessed directly from the Main screen by pressing the button displaying the current units.

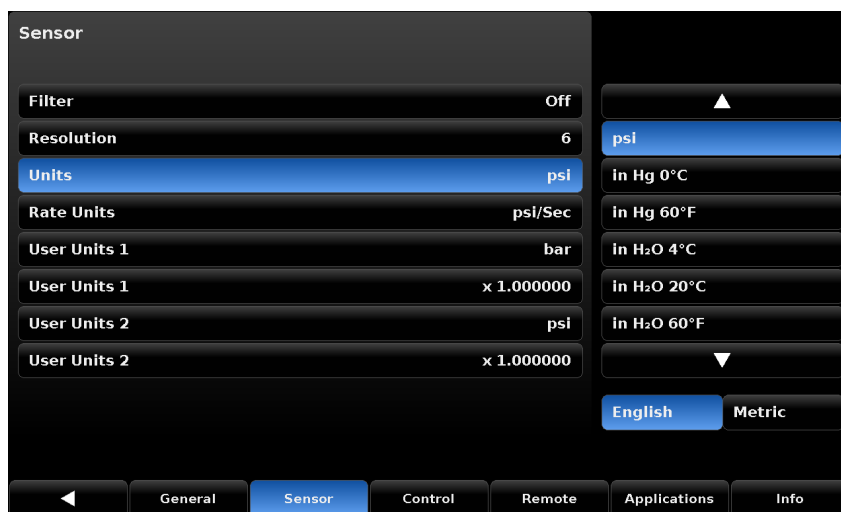

Figure 7.2.3 - Units

7.2.4 Rate Units



In the Setup [] / [Sensor] tab there is a button labeled [Rate Units]. When selected, the side bar will show a choice of time denominator units: Seconds [Sec] and Minutes [Min]. The currently selected time denominator unit (Sec or Min) will have a blue background. Selecting minute [Min] or second [Sec] will apply this time denominator to all rate functions in the instrument including [Rate Setpoint], and [Vent Rate]. When this unit is change, all rate setpoints are adjusted so they are mathematically equivalent to their current setting. For example, If the [Rate Setpoint] is set at 60 psi/min, then changing the rate denominator unit to Seconds would convert the [Rate Setpoint] to 1 psi/sec.



Figure 7.2.4 - Rate Units

7.2.5 User Units

In the Setup [] / [Sensor] tab there are several buttons with prefixes “User Units”. These are used to setup the “base unit” and multiplier used to define [User Unit 1] and [User Unit 2]. For [User Unit 1] and [User Unit 2] the process is the same. Selecting the first [User Unit #] will display a choice of [psi], [bar] or [pascal] in the sidebar. Choosing one of these “base units” will form the basis of the equation that defines the [User Unit #] chosen. Immediately below the first [User Unit #] button is the [User Unit #] Multiplier button that indicates the current multiplier and when pressed will display a keypad in the side bar where a new multiplier can be entered. These two choices are used to calculate the value of the [User Unit #] by the following equation: $\text{User Unit} = 1 \text{ Base Unit} \times \text{Multiplier}$. For example if a unit is needed, that is not currently available from the 40 choices, for instance tons per square meter (tsm), then the psi conversion factor for this can be found and is: $1 \text{ psi} = 0.703069 \text{ tsm}$. In this instance psi would be entered as the base unit and 0.703069 as the multiplier. The new user unit associated with this base unit and multiplier would now be displayed when that User Unit is chosen in the main menu or on the Setup [] / [Sensor] / [Units] screen.

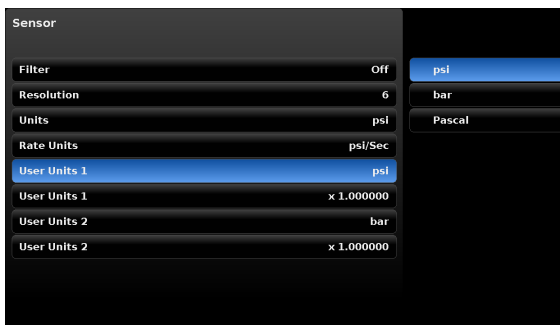



Figure 7.2.5 - User Units and User Units Multiplier

7.3 Control Tab

The [Control] tab within the Setup [] menu contains settings that limit or control display elements associated with the pressure output from the instrument's regulator. Control limits, stable window configuration, the rate setpoint, vent rate and vent limit can be found in this section.

7.3.1 Max and Minimum Limits

The [Maximum Limit] and [Minimum Limit] buttons under the Setup [] / [Control] screen provide a place to limit the setpoint that can be chosen in the main screen. These limits can only be set within the range of the active transducer. When the CPC8000 is in Autorange the limits can only be set within the range of the primary transducer which, by convention, will have the widest range. The minimum limit must be lower than the maximum limit. The operator cannot enter setpoints and thereby not control to pressures outside of these limits.

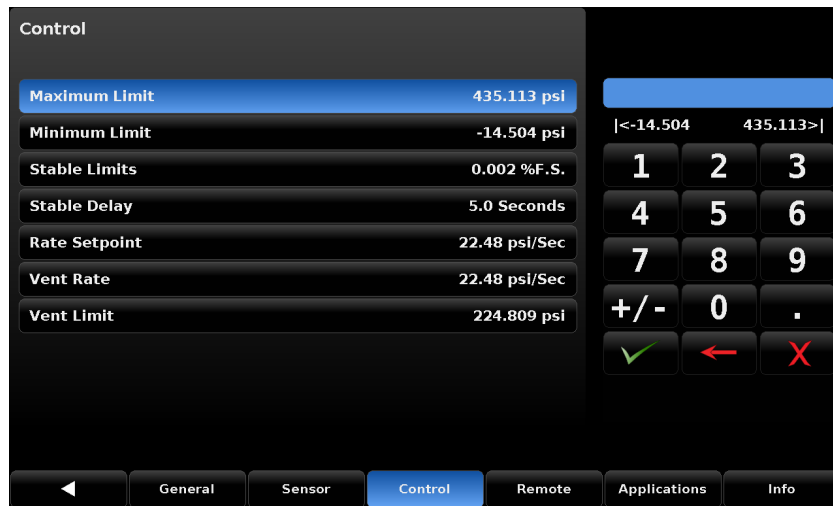

Figure 7.3.1 - Maximum Limit and Minimum Limit Buttons

7.3.2 Stable Limits

Both the [Stable Limits] and the [Stable Delay] buttons can be found under the [Control] tab in the Setup [⚙️] menu. Both of these are used to define a stable condition for pressure control or measurement (see figure 7.3.2a). When the controller enters a stable condition the font color for the pressure indication will change from white to green. For example, an operator would like the CPC8000 to show a stable indication only after the pressure output has been at the setpoint $\pm 0.002\%$ FS for 2 seconds. In this case, the [Stable Limit] should be set at 0.002, and the [Stable Delay] should be set at 2. The graphic in figure 7.3.2b illustrates this.

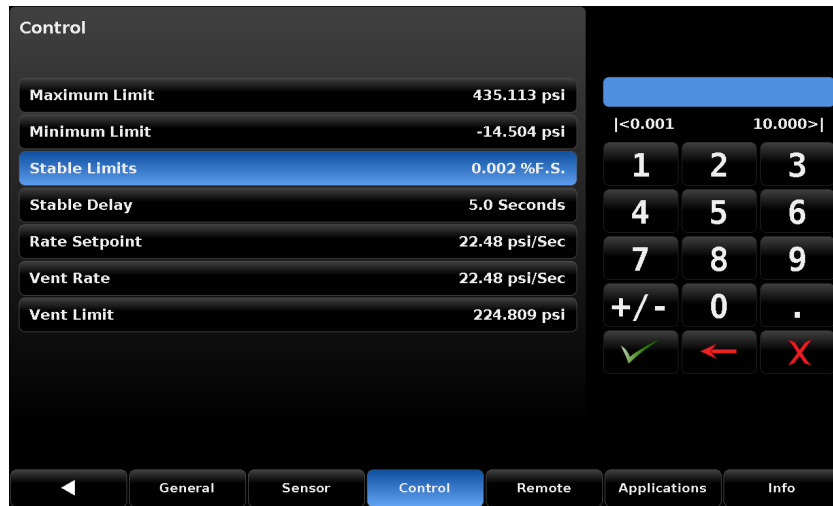

Figure 7.3.2a - Stable Limits and Stable Delay

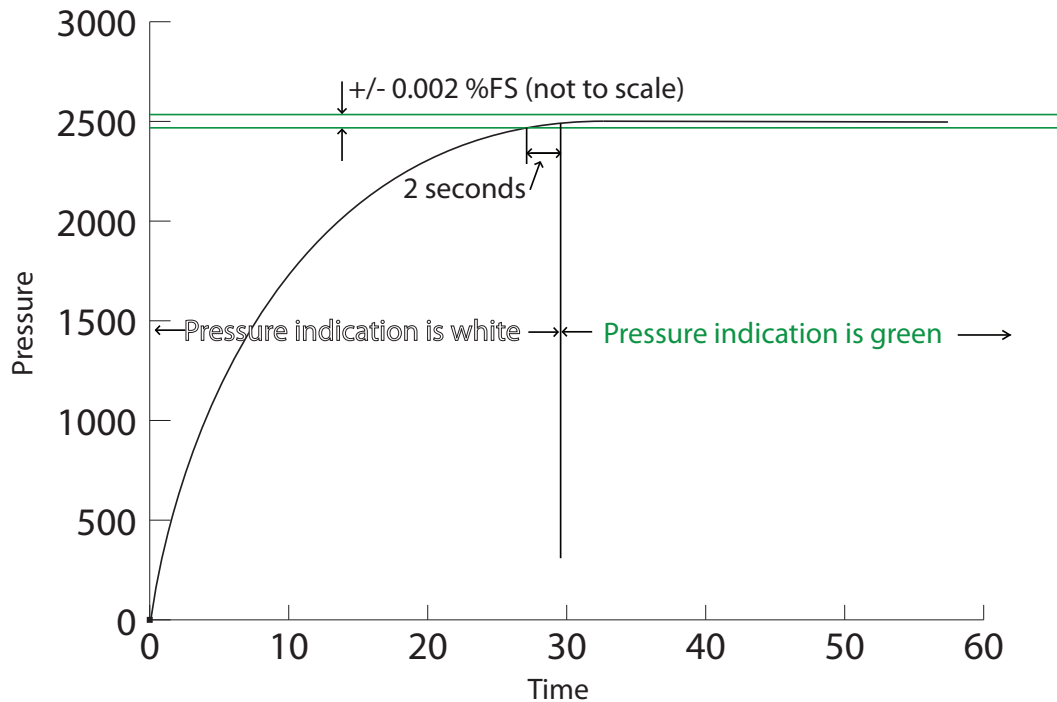



Figure 7.3.2b - Graph Illustration

7.3.3 Rate Setpoint

The [Rate Setpoint] is set in the Setup [] / [Control] menu. The rate setpoint sets the rate of pressure change when the CPC8000 is controlling up or down to a setpoint. The rate is limited to 0.001% of the full scale range/second to 10% of the full scale range/second.

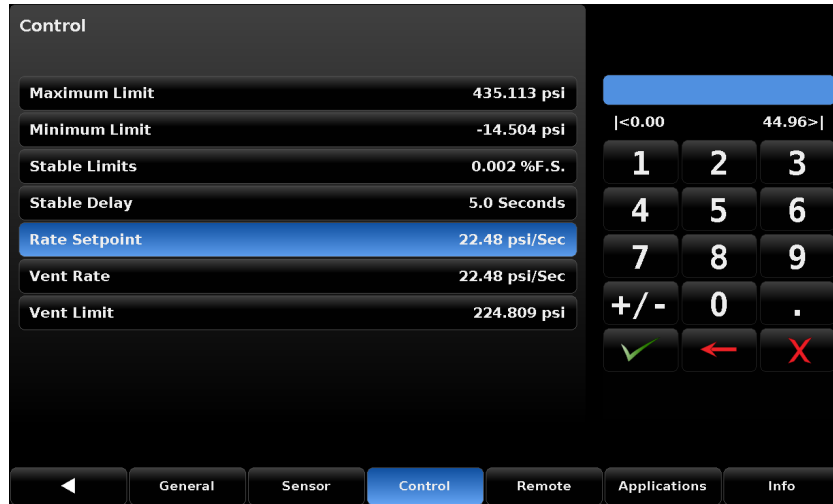



Figure 7.3.3 - Rate Setpoint

7.3.4 Vent Rate

In the Setup [] / [Control] tab, the next to the last button is [Vent Rate]. This is the rate at which the pressure will vent when in vent mode. The vent rate can be set within the values shown for the limits above the keypad and are relative to the full scale range of the primary transducer.

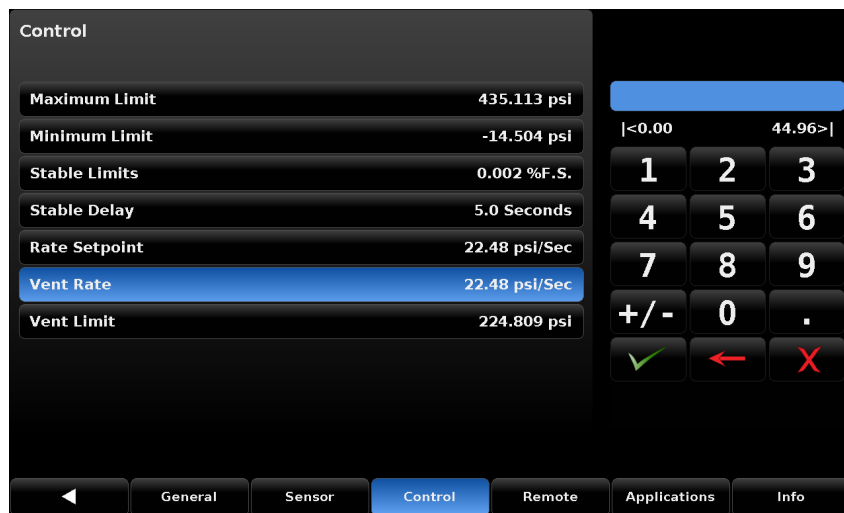

Figure 7.3.4 - Vent Rate

7.3.5 Vent Limit





In the Setup [] / [Control] tab, the last button is [Vent Limit]. This is the pressure at which controlled vent stops and the vent solenoid is opened causing the pressure to vent through the vent port uncontrolled. The vent limit can be set within the values shown for the limits above the keypad.



Figure 7.3.5 - Vent Limit

7.4 Remote Tab

The Setup [] / [Remote] tab is used to choose the command set that will be used for remote communication from an external computer, select the IEEE-488 address, configure Ethernet communication settings and configure serial communications settings. The [Remote] screen has two pages that can be accessed by pressing the page selection [ 1 : 2 ] button. Details about the remote operation and command sets are given in [Section 8, Remote Operation](#). Information about the electrical communication connection hardware is given in [Section 5.7, Electrical Connections](#).

7.4.1 Remote Command Set Setup

The [Command Set] button within the Setup [] / [Remote] tab provides a place for the operator to choose which command set that will be used within remote communication software used to remotely control the function of the CPC8000. When the [Command Set] button is chosen any of the listed command sets seen in the side bar can be selected. This will immediately change the active command set enabling the instrument to respond to commands in that set. See [Section 8, Remote Operation](#), for a list of commands included in each command set. The [Termination Character] button provides an option for the user to select the desired termination character in the output string of the instrument. In most cases this can be set to “default” where the instrument automatically chooses the termination character based on the selected command set.

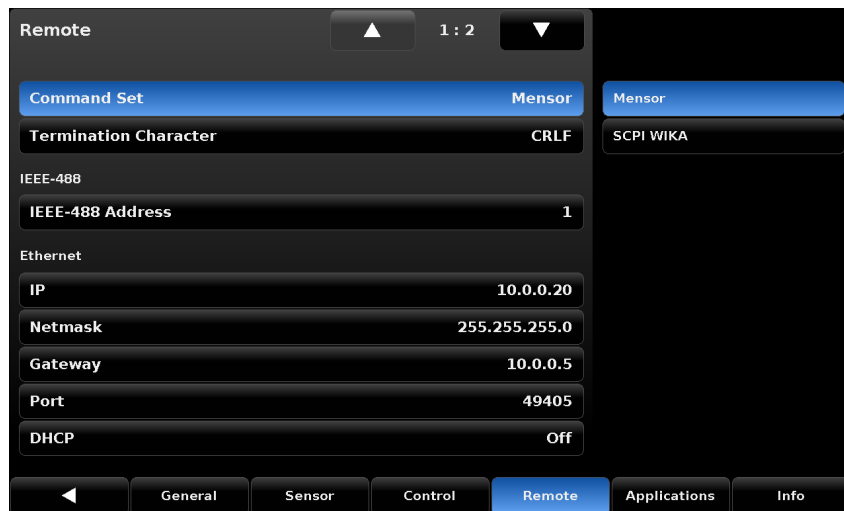

Figure 7.4.1-A - Remote Command Set Setup

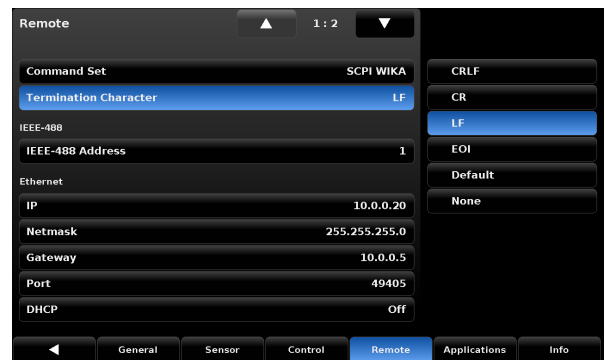
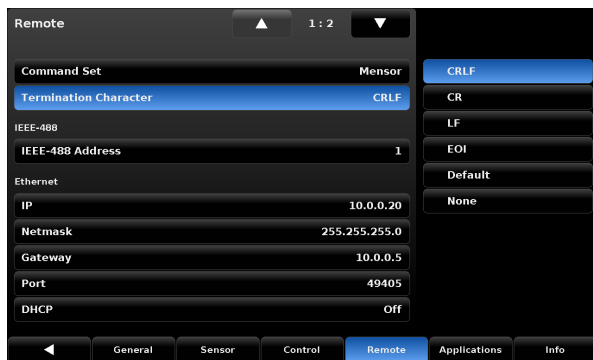



Figure 7.4.1-B - Termination Character Setup

7.4.2 IEEE-488 Address

The [IEEE-488 Address] button within the Setup [] / [Remote] tab provides a place for the operator to set the IEEE-488 Address. When the [IEEE-488 Address] button is pressed the side bar displays the numeric key pad where an address from 1 to 31 can be entered.

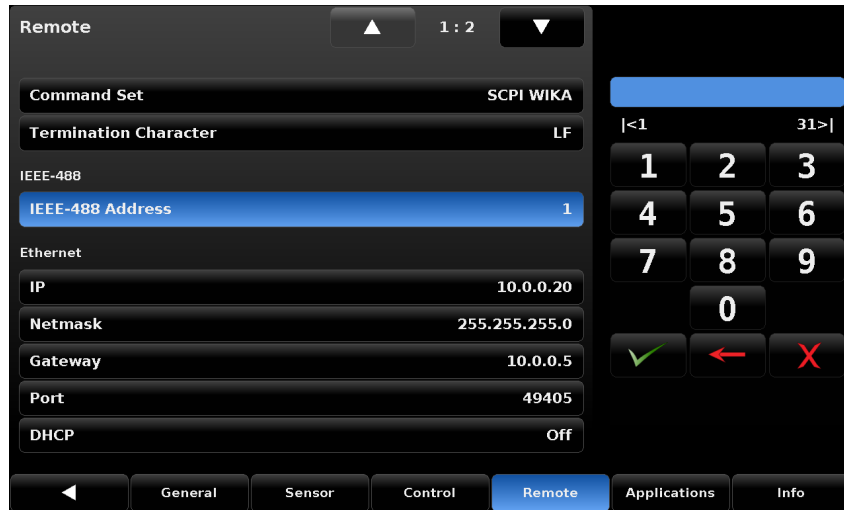



Figure 7.4.2 - IEEE-488 Address

7.4.3 Ethernet Settings

In the Ethernet section of the Setup [] / [Remote] tab there are buttons that correspond to Ethernet parameters. When the button is pressed the numeric key pad or a choice selector will be presented on the sidebar and an appropriate number or selection can be entered for the respective parameter. With DHCP turned off, a static IP address can be assigned. If DHCP is turned on and a lease is obtained successfully, the ethernet parameters are grayed and inactive but show the newly assigned lease. If a DHCP server fails to respond, DHCP will automatically turn off. Turning DHCP off allows the ethernet parameters to be edited and a static IP address assigned.

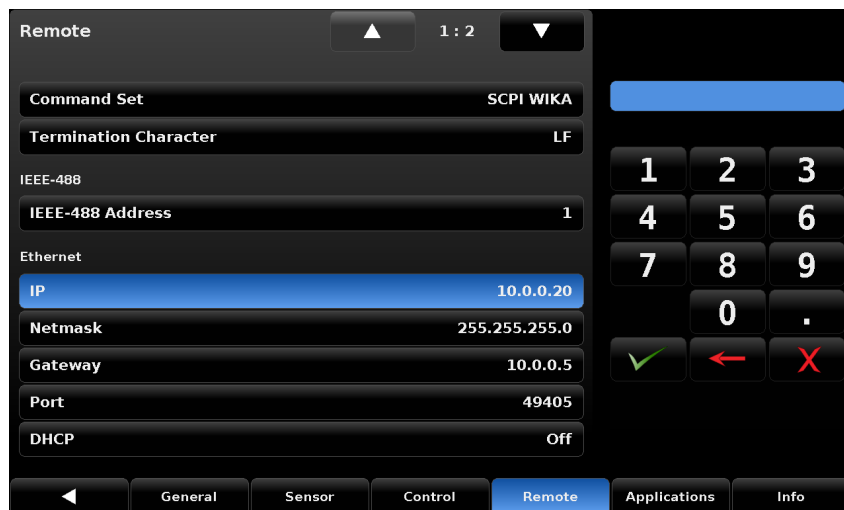



Figure 7.4.3 - Ethernet Settings

7.4.4 Serial Settings

The “Serial” section in the Setup [] / [Remote] tab can be viewed by selecting the page down button [] on the first page of the [Remote] tab. The Serial setup page has buttons that correspond to serial communication parameters. When a parameter button is pressed a choice selector will be presented on the sidebar and an appropriate selection can be entered for the respective parameter. These parameters should be set up to match your host computer.

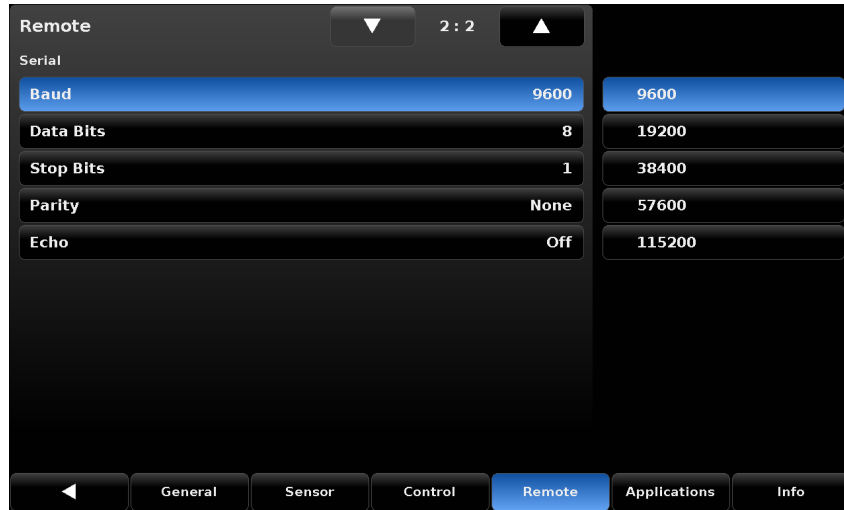



Figure 7.4.4 - Serial Settings

7.4.5 USB Device Setting

The USB Device jack is a standard USB Type B receptacle interface used for remote communication. The USB Driver can be downloaded at http://www.mensor.com/download_software_drivers_en_um.WIKA

7.5 Applications Tab

Press the [Applications] tab in the Setup [] screen and a screen will appear containing various labeled icons that when pressed access other screens that provide the following functions:

- Calibration of internal transducers
- Sequence program configuration
- Selection of favorites viewable in the main operation screen
- Setup of the Digital I/O
- A troubleshooting screen that displays errors
- An adaptation screen used for performing control adaptation for the regulator
- A tune screen used for tuning the regulator and viewing regulator characterization
- An administration screen used to manage passwords
- A software screen that allows the user to upgrade instrument/regulator software

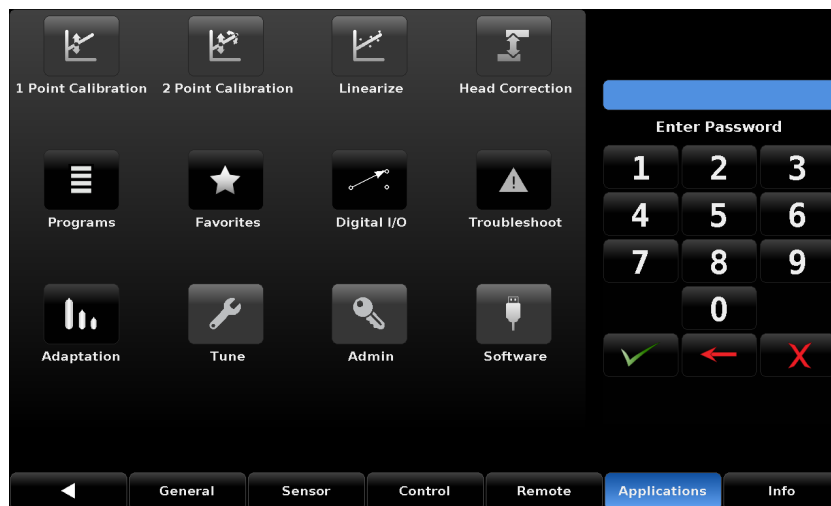

Figure 7.5 - Applications Tab

7.5.1 Passwords

All the calibration screens ([1 Point Calibration], [2 Point Calibration], [Linearize] and [Head Correction]) are password protected with the “Calibrate Password”. The “Service Password” allows access to the [Tune], [Admin] and [Software] Screens. The [Programs], [Favorites], [Digital I/O], [Troubleshoot] and [Adaptation] do not require any password for access.



Notice

The Default Passwords sent with the instrument are as follows:

Calibrate Password: 123456

Service Password: 987654

Both passwords can be changed and saved in the [Admin] page within the [Setup] [] / [Applications] section.

If the passwords are forgotten, contact Mensor or your local Mensor service center for instructions to access the protected areas and to reset the passwords.

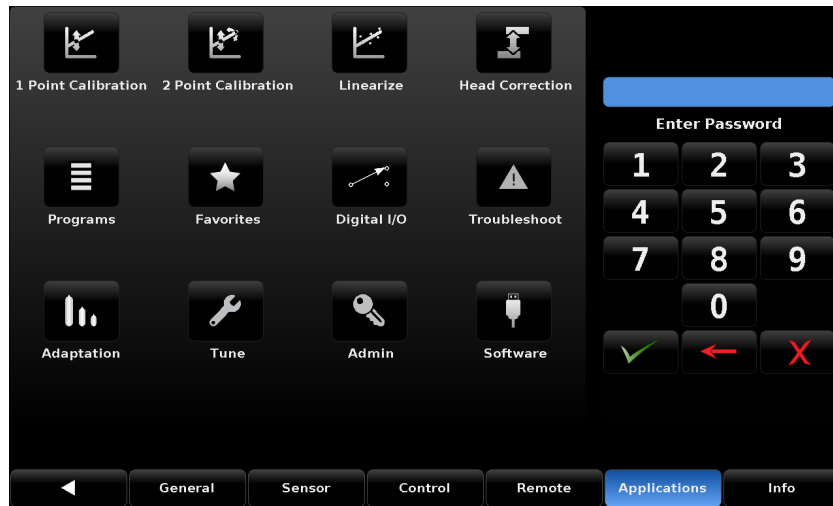

Figure 7.5.1 - Applications Tab, Unlocked

7.5.2 Calibration of Internal Transducers

The top row of labeled icons in the [Applications] screen are the password protected applications for calibration of the CPC8000 internal transducers. Calibration can be performed by the owner of the instrument or sent back to Mensor for a ISO-17025, A2LA accredited calibration.



Notice

NOTICE: Each re-calibration at the factory includes a free comprehensive evaluation of all system parameters. During the first re-calibration at the Mensor factory a service file is started in which every calibration and all extra services are recorded.

This section is included for those who wish to calibrate their CPC8000 within their own calibration lab. Because calibration involves special training and calibration components that are not addressed here, only personnel qualified in calibration procedures should be allowed to calibrate the CPC8000.



Caution

CAUTION! Only qualified personnel should be allowed to calibrate the CPC8000.

A Mensor recommended calibration setup is addressed in [Section 7.5.2.4, Calibration Setup](#). The CPC8000 pressure reading is automatically adjusted for the effects of temperature and non-linearity within the calibrated temperature range of 15-45°C. The process is referred to as dynamic compensation because each reading is adjusted before it is output to the display or to a communication bus. Thus, a calibrated CPC8000 operated within its temperature band, and with proper zero and span adjustments, will provide accurate pressure measurements.

The CPC8000 should have the calibration verified periodically to insure its stability. Initially, the recommended period between calibration is 6 months or one year, depending on the range. This period may be extended as confidence is gained in the span stability.

7.5.2.1 Calibration Environment

For maximum accuracy, allow the CPC8000 to warm up for a minimum of 30 minutes in an ambient temperature within the compensated range prior to commencing a calibration. In addition the instrument should be at rest on a stable platform that is free of excessive vibration and shock.

7.5.2.2 Calibration Pressure Standards

Mensor recommends the use of appropriately accurate pressure standards when calibrating this instrument. Such standards should be sufficient so that when the techniques of the ISO Guide to the Expression of Accuracy in Measurement (GUM) are applied, the instrument meets its accuracy statements as required by ISO/IEC 17025:2005, or other applicable standards.

7.5.2.3 Calibration Media

Gas media are required for calibration. The recommended medium is dry nitrogen or clean, dry, instrument air.

7.5.2.4 Calibration Setup

Refer to the calibration setup illustration on the following page ([see figure 7.5.2.4 - Calibration Setup](#)). The illustration shows a typical calibration setup for absolute and gauge pressure instruments.

The 'Pressure Standard' is normally a deadweight tester, a precision piston balance or a precision manometer. The 'Volume Controller' refers to a hand operated variable-volume pressure vernier device. A diaphragm type vacuum gauge is recommended over the gauge tube type of vacuum transducer for calibrating sub-atmospheric pressures (shown in the illustration under "Setup for Absolute Pressure"). A vacuum source with a capacity to generate 600 mTorr absolute is recommended.

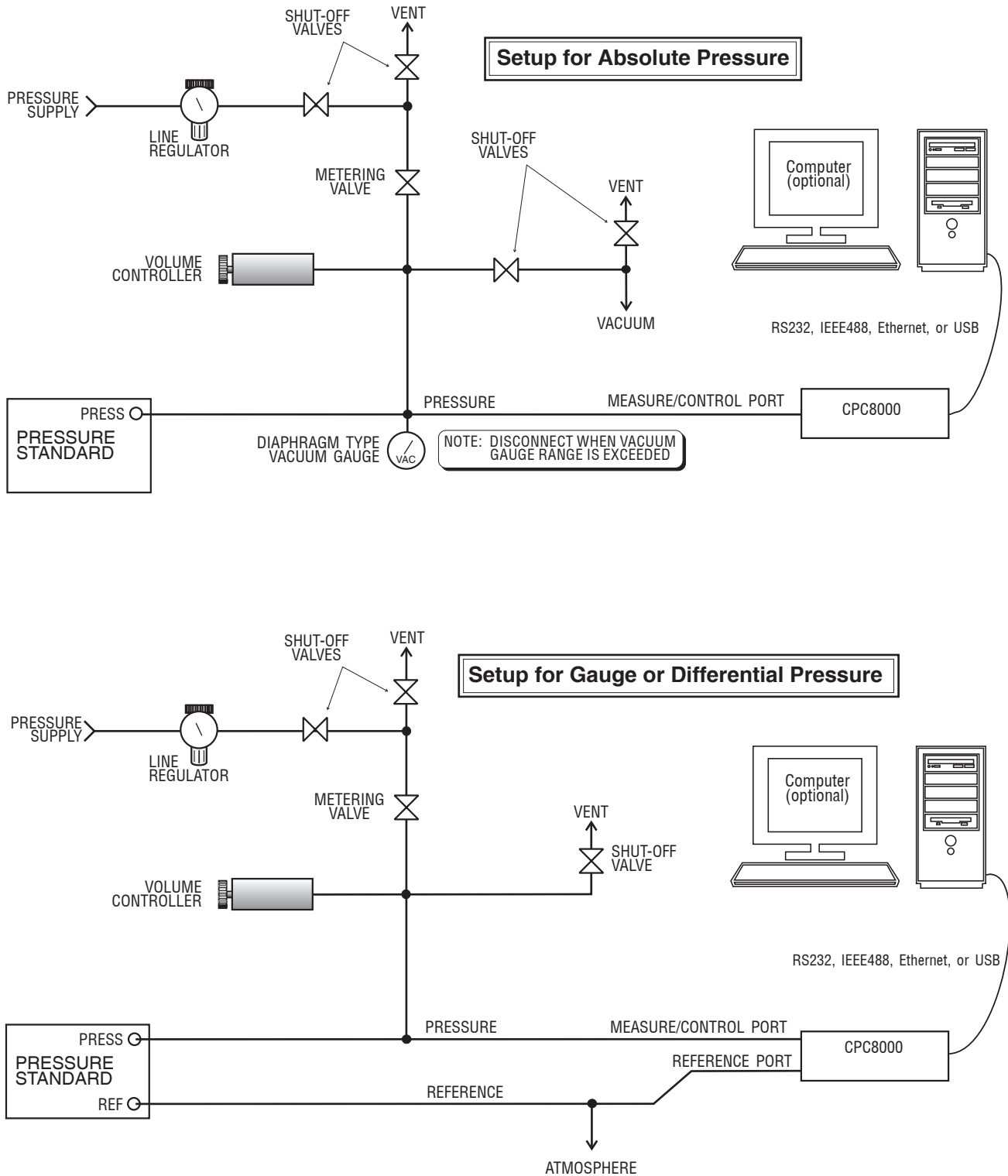

Figure 7.5.2.4 - Calibration Setup

7.5.2.5 Calibration Adjustment Procedure

There are three methods that can be used to calibrate all of the transducers in the CPC8000. A simple [1-Point Calibration] can be used to adjust a single point (usually the zero point). A [2-Point Calibration] extends this capability to adjust two points (usually points close to the Zero and Span). The [Linearize] calibration provides a way to calibrate and linearize the pressure curve using from 1 to 10 points over the range of each transducer. The Remote Zero Calibration is similar to the 1-Point Calibration but is not permanent (does not persist through power cycles).

Procedures for use and interaction with all the calibration screens can be found in the following sections of this manual:

- 1 Point Calibration — [See Section 7.5.2.5.1](#)
- 2 Point Calibration — [See Section 7.5.2.5.2](#)
- Linearize Calibration — [See Section 7.5.2.5.3](#)
- Head Correction — [See Section 7.5.2.5.4](#)
- Remote Zero Calibration — [See Section 7.5.2.5.5](#)



Notice

When calibrating the CPC8000, adjust for the difference in level between the pressure standard and the instrument (head) must be considered. See [Section 7.5.2.5.4](#) to view and adjust the head correction.

7.5.2.5.1 1-Point Calibration

The 1 Point Calibration screen provides a place to calibrate an internal transducer or the optional barometer using a single pressure point. This is usually done to adjust the zero point of a transducer. The transducer being calibrated is chosen by pressing the [Primary], [Secondary], [Tertiary] or [Barometer] tab at the bottom of the screen (see figure 7.5.2.5.1 below).

With a gauge transducer the instrument is simply vented using the [Vent] button and, after a stable pressure is seen, 0 (zero) is entered by pressing the [New Value] button which will open a numeric key pad.

With an absolute transducer, the instrument should be put in [Measure] mode with an appropriate high accuracy reference standard connected to the Measure/Control port on the back of the CPC8000. If a sub-atmospheric zero point is required, a vacuum pump can be connected to the Measure/Control port to bring the pressure down to a value closer to absolute zero. Mensor recommends a value greater than or equal to 600 mtorr. The value for the absolute pressure reading from the reference standard should be recorded by pressing the [New Value] button.

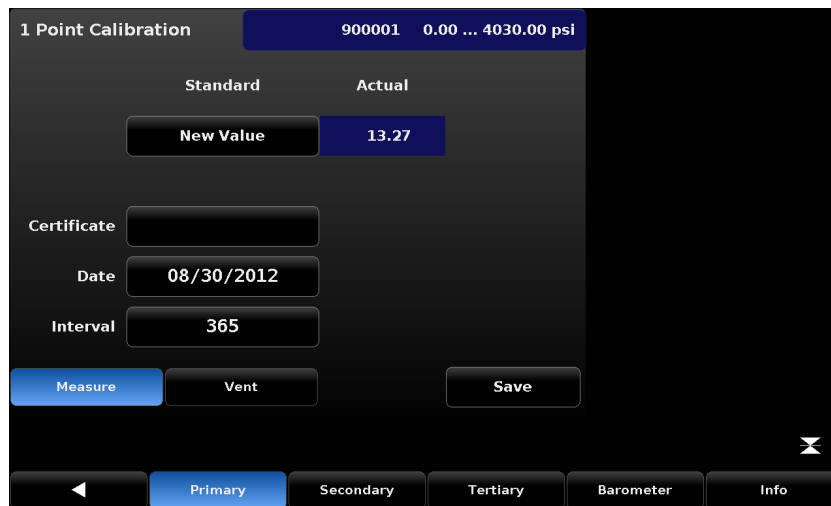

Figure 7.5.2.5.1 - 1 Point Calibration

A certificate number can be entered by pressing the [certificate] button. The date can be entered by pressing the [Date] button. The calibration interval can be viewed and changed by pressing the [Interval] button.

7.5.2.5.22-Point Calibration

A 2 Point Calibration adjusts both the “zero” (low point) and the “span” (high point) of the active transducer. This is accomplished by interacting with the “2 Point Calibration” screen (see figure 7.5.2.5.2).



Figure 7.5.2.5.2 - 2 Point Calibration

Follow the steps below for a complete 2 Point Calibration:

- Select a Transducer to calibrate by pressing one of the available transducer tabs at the bottom of the screen, in this case [Primary] [Secondary], [Tertiary], or [Barometer].
- Ensure that the head correction is adjusted properly ([see Section 7.5.2.5.4](#)).
- The 2 point calibration screen is accessed through the password protected portion of the Setup []/[Applications] area. See [Section 7.5.1](#) for the default password.
- To calibrate the “low Point”:
 - The Measure /Control port of the instrument should be supplied with a suitable, “low point” pressure (see [Section 5.6, Pneumatic Connections](#), for the port location).
 - For a gauge transducer, this low point pressure can be achieved by Pressing the [Vent] button on the 2 Point calibration screen and wait for the reading to stabilize at, or close to, zero.
 - For an absolute transducer a suitable source of vacuum should be applied to the Measure/Control port along with a high accuracy vacuum standard or a pressure calibration standard should be connected to the Measure/Control port that can generate and measure a pressure value. In either case the pressure should be measured at a stable value that is a value between 600 mTorr absolute and 20% of the selected internal transducer’s span.
 - When the pressure is stable the [Reading] button, under the “Actual” label and on the row labeled “Low Point”, should be pressed. This action accepts the value and it will appear with a green background where the [Reading] button was.
 - Press the [New Value] button and, via the numeric key pad, enter the “true pressure” obtained from the calibration standard. This value will be (0) zero in the case of a gauge transducer that is vented, otherwise it should be obtained from the pressure measured by your calibration standard. After the value has been accepted by pressing the [check] mark on the numeric key pad the value will appear with a green background where the [New Value] button was. These actions complete the low point

calibration.

- To calibrate the "High Point":
 - The "High Point" Calibration is done in a similar way as the "Low Point" but should be performed in [Measure] mode.
 - Place the instrument in Measure mode by pressing the [Measure] button within the 2 point Calibration Screen.
 - Supply a pressure to the Measure/Control Port using a pressure standard. This pressure should be as close as possible to the full scale value of the selected transducer or at least within 20% of that value. The [Too Low] button will change to a [Reading] button when the pressure reaches an acceptable range.
 - After the pressure stabilizes, select the [Reading] button to accept the instrument's reading of the pressure input. The actual reading will appear within a green background where the [Reading] button was.
 - Press the [New Value] button and enter the "true pressure". This value is obtained from the pressure measured by the calibration standard. After the value has been accepted by pressing the check [✓] mark on the numeric key pad, the value will appear with a green background where the [New Value] button was. These actions completes the High Point calibration.
 - The [Save] button will now be active, press it to store the values in the transducer.

7.5.2.5.3 Linearize

The [Linearize] application (see figure 7.5.2.5.3a) provides a place to record [As Found] calibration data and to linearize each internal transducer in the CPC8000 using that data. An "as found calibration" can be performed by connecting a suitable pressure standard to the Measure/Control port, placing the instrument in [Measure] mode and supplying all 11 pressure points across the complete range of the transducer being calibrated. The record of the pressures generated or measured by the pressure standard and the corresponding reading from the instrument's transducer can be recorded and transcribed into the [Linearize] / [As Found] screen. The screen is accessed by pressing the [As Found] button in the [Linearize] screen.

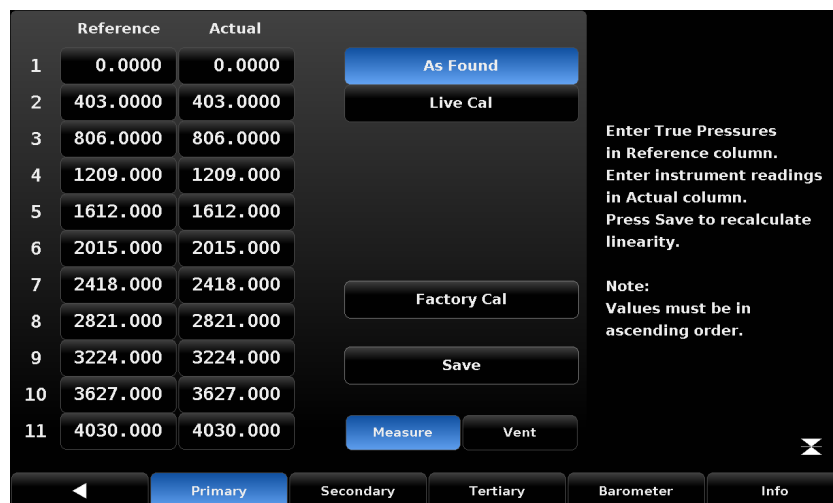



Figure 7.5.2.5.3a - Linearize / As Found

In the [Linearize] / [As Found] screen choose the transducer to be linearized by pressing the [Primary], [Secondary], [Tertiary], or [Barometer] button. Pressure test points generated by the reference standard are entered in the column labeled "Reference"; each of the corresponding readings from the instrument's

transducer should be entered into the column labeled “Actual”. To enter readings, simply press the corresponding point in the “Reference” or “Actual” columns and a data entry keypad will appear on the side bar. Enter and accept the point using the key pad and check []. Pressing the [Save] button linearizes the internal transducer based on the “As Found” data entered.

Linearization can also be accomplished for each transducer in a “live Calibration” by pressing the [Linearize] / [Live Cal] button. The Live Cal allows the calibration technician to perform the calibration and linearization for each transducer in a more direct way. In the Live Cal, the reference standard is connected to the Measure/Control port and the CPC8000 is placed in Measure mode. Choose the transducer to be tested by pressing the [Primary], [Secondary], [Tertiary], or [Barometer] button. The reference pressure generated by the standard is recorded in the “Reference” column for each point. The reading of the internal transducer for each pressure point can be seen directly in the “Reading” window. Pressing the corresponding point under the “Actual” column will accept that reading into that point. Subsequent pressure points generated by the pressure standard are accepted and recorded in the same way. After all points are entered, press the [Save] button to linearize the internal transducer based on the “Live Cal” data.

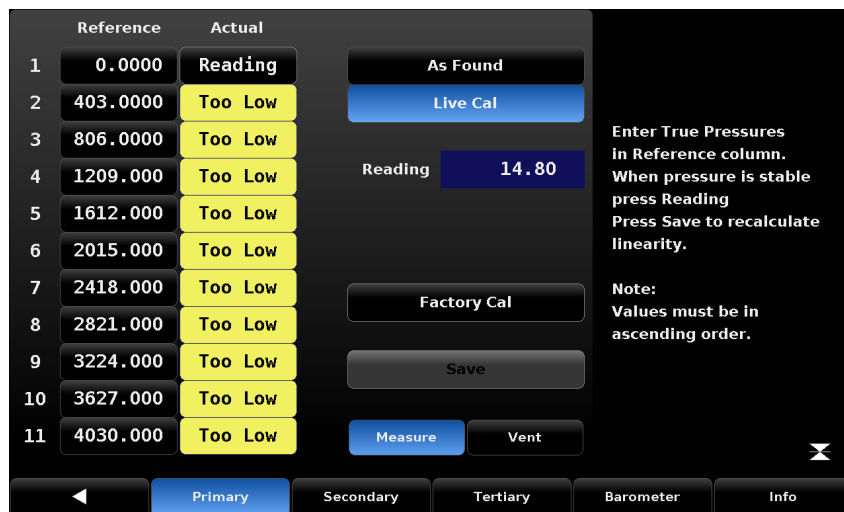



Figure 7.5.2.5.3b - Live Cal

At any time the [Factory Cal] button can be pressed to revert back to the factory calibration.

The Reference points and Actual points can also be sent over the remote bus for automated transducer linearizations. First ensure the instrument is not in Autorange by sending “Sensor <n>” where <n> is the transducer you wish to linearize, or by bringing up the Linearization screen from the Applications menu (this automatically takes the CPC8000 out of autorange). Set each reference pressure with the command “Desiredpress <n>,<pressure>” where <n> is the 0th based index. “Desiredpress 0,0” will set the 1st Reference point’s value to 0. “Desiredpress 1,1.5” will set the 2nd reference point to 1.5, etc. Each subsequent reference point must be greater in value than the previous point. It is advised to send all of your Reference points first before proceeding. Use your reference (e.g. CPB6000) to control the pressure on the measure port to the Reference/desired pressure. Then send the pressure reading over the bus with the command “Actualpress <n>,<reading>” where <n> is the 0th based index. This reading should be within +/- 1%FS of the Reference point. Using Figure 7.5.2.5.3a for example, if you have sent “Desiredpress 3,1209.0”, you would send “Actualpress 3,<reading>” where <reading> must be between 1168.70 and 1249.30. Send each of the 11 readings with the “Actualpress” command and then send “Calculate_as_found_linearity” and then “Save_linearity”. Your active transducer linearization is now complete.

7.5.2.5.4 Head Correction (password protected)

The Setup [] / [Applications] / [Head Correction] screen is the place to enter parameters that affect the offset that occurs when the device is being calibrated and located at a different level (elevation) compared to the transducer inside of the CPC8000. Touching any of the active buttons in this screen will activate the number key pad. Each of the four rows in figure 7.5.2.5.4 represent a different parameter in the head correction calculation. In the [Height (INST-DUT)] row, the level of the Device Under Test (DUT) should be subtracted from the instrument reference point (INST) and entered. The gas density used within the calibration system, the gas temperature, and the local gravity should be entered in the subsequent fields. The default height is zero (0) indicating that there is no head correction applied. [English] or [Metric] units can be chosen by pressing the related button.

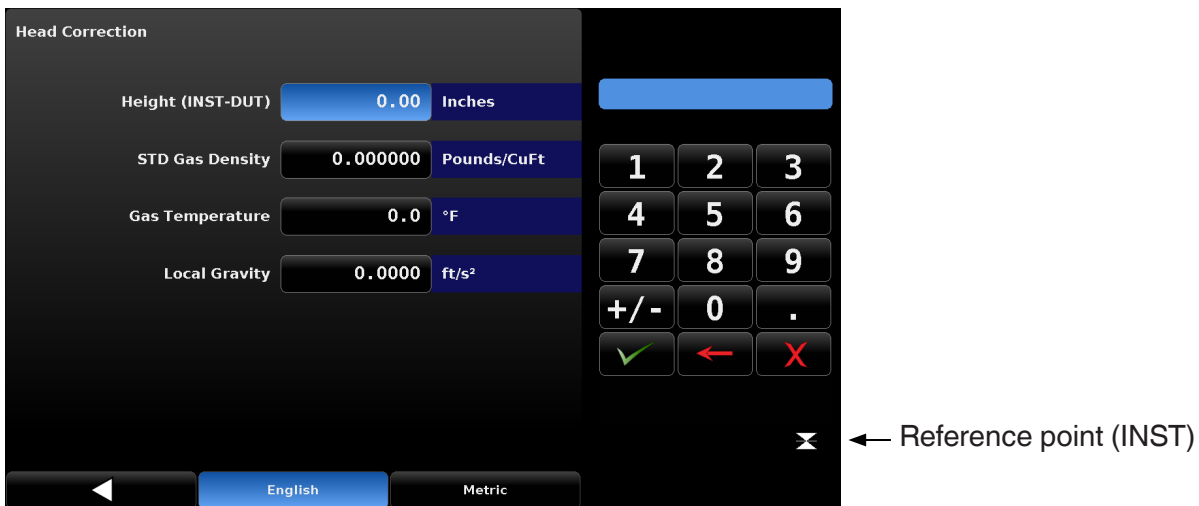

Figure 7.5.2.5.4 - Head Correction Screen

7.5.2.5.5 Remote Zero Calibration

There are two types of zeros that may be applied. The first type is a zero that applies to the transducer and the second type is a zero that applies only when the transducer is in an emulated pressure mode (e.g. absolute emulation with a native gauge, or gauge emulation with a native absolute). The emulation mode zero is not saved/stored to the transducer, and is disabled when you switch back to the native mode and re-enabled when you switch to the emulated mode. This way, an absolute transducer may be zeroed in gauge emulation without it affecting the absolute mode's reading. Clearing the emulation zero, by sending "ZERO ?" when in emulation mode, does not reset the native zero. Clearing the native zero, by sending "ZERO ?" when in native mode, clears both the native and the emulation zero. Typically it is used to set a daily zero as barometric pressure changes but can be used to correct at any measured value. There are several commands that can set the zero for the transducers. In the Mensor command set they are "ZERO" and "AUTOZERO" and require "CALDISABLE" to be turned off. In the SCPI command set they are "CAL:PRES[R]:ZERO" and "CAL:ZERO:RUN" and do not require CALDISABLE to be turned off.

"ZERO" will set the zero for the currently active transducer. It is advised to be in vent mode and at atmospheric ambient pressure. "CAL:PRES[R]:ZERO" works the same as "ZERO" except you can specify which transducer you wish to zero. If Sensor 1 is active, the protection solenoids for Sensors 2 and 3 (if present) are enabled. This means there could be trapped air between the solenoid and transducer that

could be different than ambient atmosphere pressure, even if vented. When specifying the transducer with “CAL:PRES[R]:ZERO”, it is advised to be in autorange and vent mode, or to have the target transducer active and in vent mode.

“AUTOZERO” places the instrument in vent, sets the range to autorange if there is more than one transducer present and waits for the pressure reading to become stable. If the pressure reading is not stable within 180 seconds, an error will be generated and the autozero sequence will abort. The autozero routine then sets the zero to 0 for each transducer present. The autozero routine will return the instrument to the initial configuration (active transducer/autorange and measure type) when complete. “CAL:ZERO:RUN” works the same as “AUTOZERO” except it does not require CALDISABLE to be turned off. Only native gauge transducers, or absolute transducers with a barometer can be zeroed with AUTOZERO/CAL:ZERO:RUN.

While zeroing, the screen is locked (KEYLOCK ON) so that the operator cannot change the configuration of the instrument. After the zeroing is complete, KEYLOCK is returned to its pre-zeroing state. If you zero multiple transducers with the “ZERO” or “CAL:PRES:ZERO” commands, please allow approx. 10 seconds inbetween zeroing commands to allow the previous zero to complete. The zero offset can be queried with “ZERO?/CAL:PRES[R]:ZERO?” and cleared with “ZERO ?”. There is not a SCPI command to clear the zero.

7.5.3 Programs

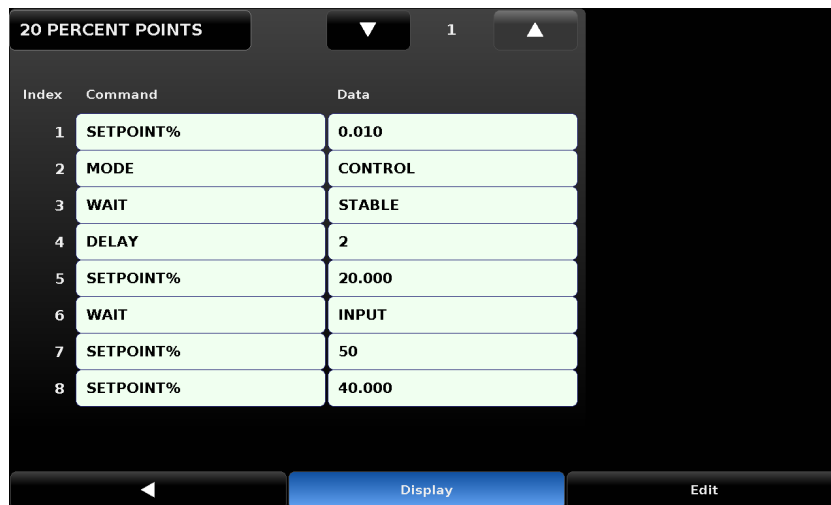

The Setup [] / [Applications] / [Programs] screen is used to create, view and edit programs that are used to automatically run a sequence of commands within the CPC8000. There are two tabs at the bottom of the Program screen shown in figure 7.5.3a. The Display tab provides a place to view each program or add a new one. Pressing the program label (program selection button) at the top left will allow selection of predefined programs from the side bar plus a set of blank labels where new programs can be entered.



Index	Command	Data
1	SETPOINT%	0.010
2	MODE	CONTROL
3	WAIT	STABLE
4	DELAY	2
5	SETPOINT%	20.000
6	WAIT	INPUT
7	SETPOINT%	50
8	SETPOINT%	40.000

Figure 7.5.3a - Programs

With the [Edit] tab selected (figure 7.5.3b) the operator can edit existing programs or create steps in new ones. Pressing a Command or Data point will present the available commands, or a data entry selections in the side bar. The [Insert] and [Delete] buttons allow insertion and deletion of lines. Selection of commands and data in each sequential line will create a draft of resulting command sequence in the selected program, upon exiting the edit mode with the back button [] the instrument will ask “Replace old

values?'. Pressing the [] will accept the changes, pressing the [] will revert back to the old program. A list of available commands, data values and their functions are listed in table 7.5.3.

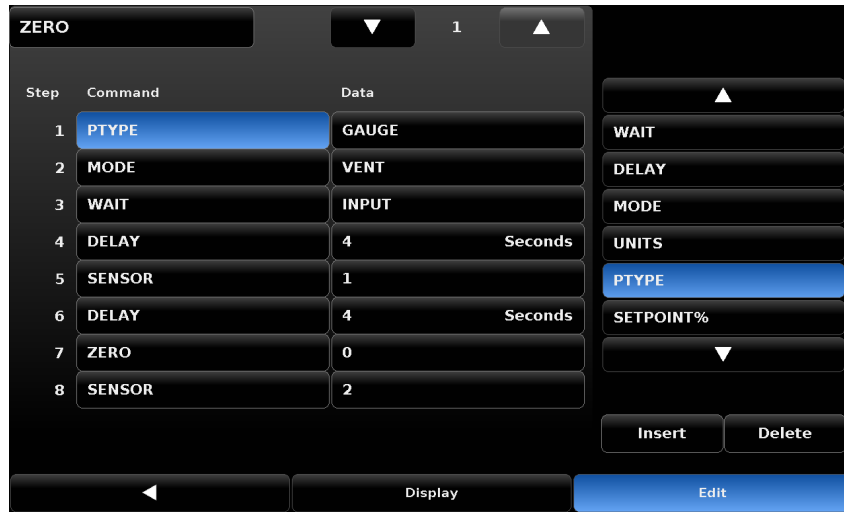



Figure 7.5.3b - Programs

Table 7.5.3 - Sequence Commands

Command	Function (data selection)
DELAY	Delays for time = 1 to 3600 seconds (Numerical Entry)
MODE	Sets the control mode (Measure, Control or Vent)
PTYPE	Sets the pressure type (Gauge or Absolute)
RSETPT	Sets the rate setpoint in current units (Numerical Entry)
RUNITS	Sets the rate denominator time unit (min or sec)
SENSOR	Sets the active transducer (1, 2 or 3)
SEQSTART	Starts the sequence from the beginning (None)
SETPOINT	Sets the control setpoint for the instrument (Numerical Entry)
SETPOINT%	Sets the control setpoint in % of current range (Numerical Entry)
WAIT	Waits for a manual input or stable condition (Stable or Input)

7.5.4 Favorites

The Setup [] / [Applications] / [Favorites] screen is used to select programs that will appear in the main screen when the Favorites [] icon is pressed. The current list of favorites is shown in figure 7.5.4 on the left. Press one of these and then press the available programs on the right to update the current favorites list with that program.

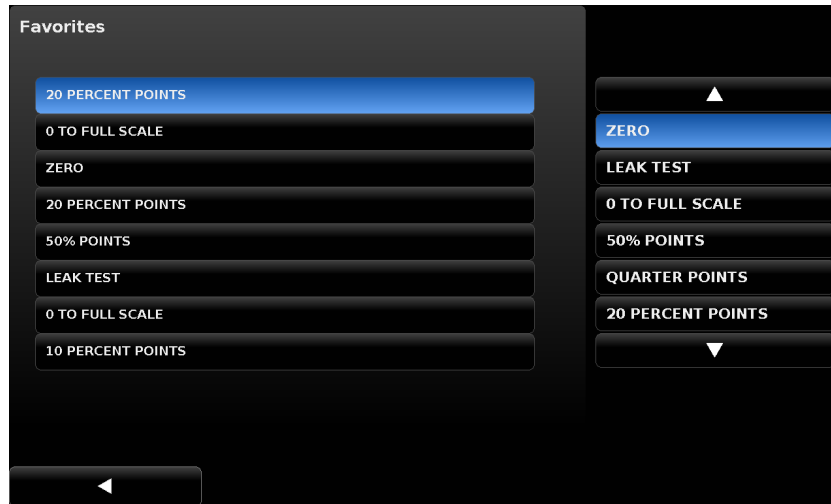



Figure 7.5.4 - Favorites

7.5.5 Digital I/O

The Setup [] / [Applications] / [Digital I/O] screen provides a place for the operator to assign conditions or actions to the digital inputs and the digital outputs, the default screen will show all inputs and outputs turned off.

In figure 7.5.5a Digital I/O [Input 1], [Input 2] and [Input 3] are assigned to the [Measure], [Control] and [Vent] modes respectively. When a digital signal (switch closure) is sent to the “1”, “2”, or “3” input terminal on the back panel of the instrument the instrument mode will change to “Measure”, “Control” or “Vent”. Each input can be assigned to one of the choices listed on the right by pressing the input then the choice. [Keylock] will lock out the touch screen interface preventing local operation and [Start] will start the most recent program selected in Favorites [] menu.

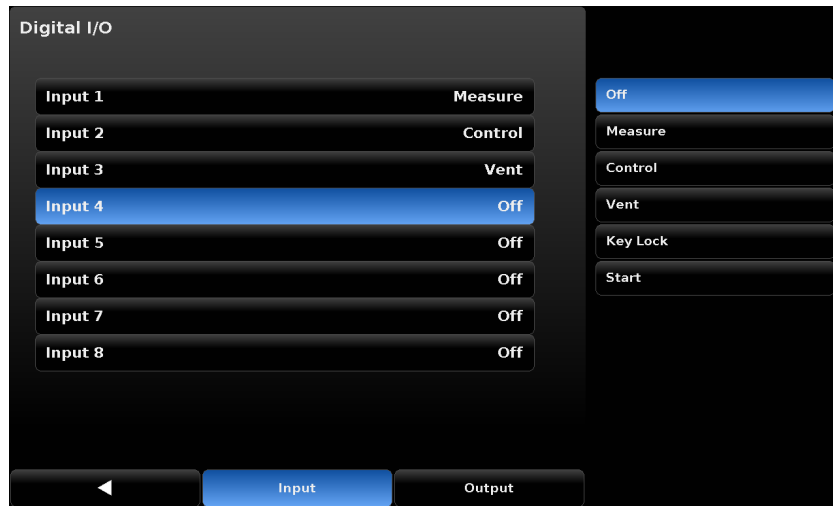

Figure 7.5.5a - Digital Input

In figure 7.5.5b Output 1 (one) is assigned to the [Vent] mode of the instrument. Output 1 will be energized when the CPC8000 is in Vent mode. Each output can be assigned to one of the choices listed on the right by pressing the output and then the choice. Each output switch will be energized when the assigned instrument mode is active. When the mode is inactive the assigned output switch will be de-energized. The “Pump” choice indicates that the regulator requires a vacuum pump to be on in order to control to a sub-atmospheric pressure. The pump output is used to turn on or off a vacuum pump as needed. See [Section 5.7, Electrical & Communication Connections](#) for pinout description.

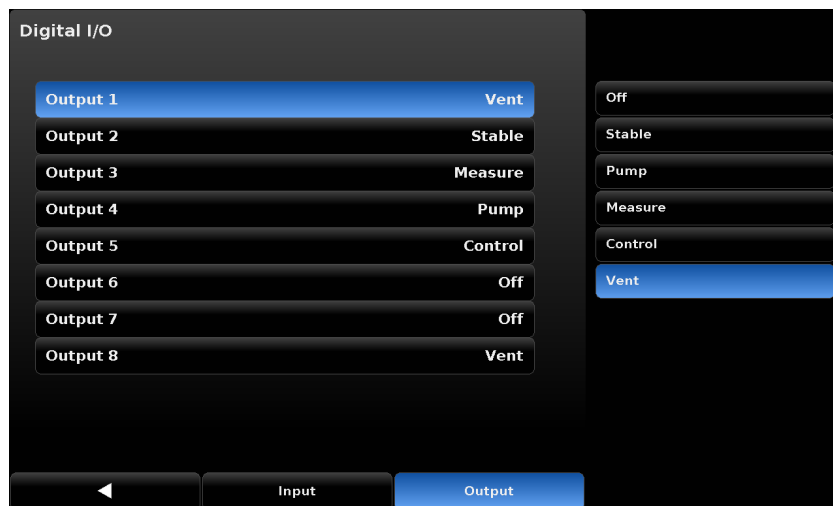



Figure 7.5.5b - Digital Output

7.5.6 Troubleshoot

The Setup [] / [Applications] / [Troubleshoot] screen provides a list of internal or remote errors that may have occurred. Figure 7.5.6 below gives an indication that the CPC8000 access door has been opened. Once the errors have been viewed in this screen, they are cleared. The [Remote] tab shows communication send/receive messages that have been made through one of the remote communication ports and is helpful in de-bugging remote control software programs.

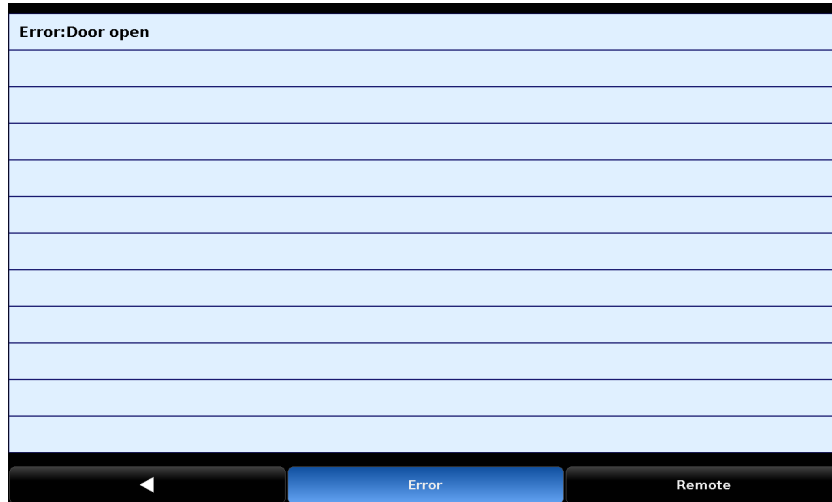

Figure 7.5.6 - Troubleshoot

7.5.7 Adaptation

The [Applications]/[Adaptation] screen allows configuration of the CPC8000 to deliver best performance in different conditions like changes in supply pressure, control volume and reference transducers. The Adaptation section consists of two screens; Adaptation and Configuration. The Adaptation allows the user to set up parameters for running the adaptation test. The Configuration screen allows saving and loading each unique configuration to the regulator.



Figure 7.5.7a - Control Adaptation Screen

Pressure Min: The minimum pressure the Needle Valve Regulator (NVR) will be characterized for. This value may not be changed.

Pressure Max: The maximum pressure the NVR will be characterized for. This value must be set to 10% below the supply pressure connected to the supply port of the instrument. Figure 7.5.7b shows the value can be entered by the keyboard in the sidebar.



Figure 7.5.7b Pressure Max Entry



Caution

CAUTION: It is recommended to not set the pressure max value below 50% of the maximum pressure range of the primary transducer.



Caution

CAUTION: The control upper limit will be updated to match the pressure max value. After characterizing an NVR for a certain range, the control upper limit should not be set higher than this amount.

Gain Inlet Position: Supply needle valve position during the adaptation test. Setting this value higher will make the test take less time, as the valve will be opened more. Setting this value lower will close the valve more during the test, causing the flow rate through the valve to be less and may allow for a better characterization of the valve, and better performance.

Gain Outlet Position: Exhaust needle valve position during the adaptation test. Setting this value lower (more negative) will make the test take less time, as the valve will be opened more. Setting this value lower will close the valve more during the test, causing the flow rate through the valve to be less and may allow for a better characterization of the valve, and better performance.

[Default]: Loads default values for Pressure Min, Pressure Max, Gain Inlet Position and Gain outlet Position based on factory settings and the maximum range of the primary transducer installed.

[Start]: Performs the control adaptation test, changing the pressure in the instrument from the pressure minimum to the pressure maximum, then back down to the pressure minimum. Upon successful comple-

tion, the status box will display “Complete”.

[Cancel/Abort]: Performs a controlled vent back to atmospheric pressure and stops the control adaptation test.



Caution

CAUTION: If an emergency vent of the system is required for any reason, press the power button and turn off the instrument.

[Restore Factory]: Loads all of the factory settings back into the instrument.

The status of the adaptation test can be observed in the top left area of the [Adaptation] screen. Figure 7.5.7c shows different status messages.

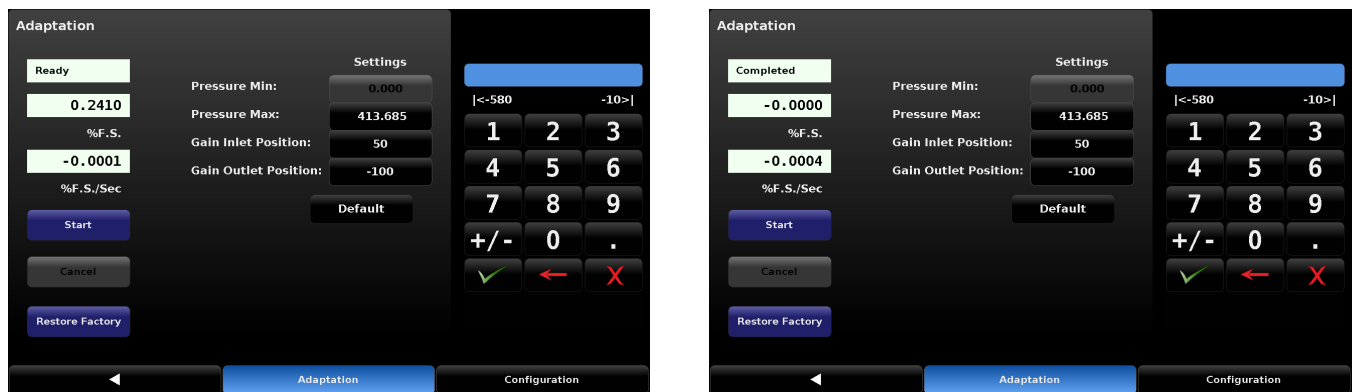

Figure 7.5.7c - Adaptation test status

The [Configurations] button at the bottom right allows access to the Configuration screen. The Configuration screen stores eight adaptation tests within the CPC8000 for easy access in the event of change in operating conditions. The figure 7.5.7d shows the Configuration screen. By default all the configurations are set to factory settings.

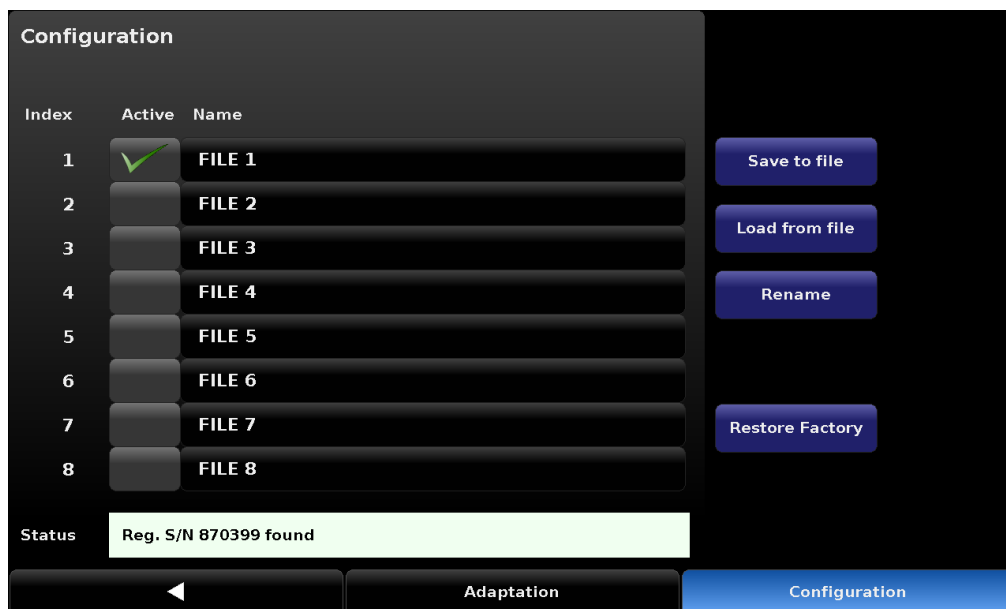



Figure 7.5.7d - Configuration screen

To rename a configuration file, simply click on the name of the file to activate it and press the [Rename] button, this will open an alpha numeric keypad. Simply type the desired name and click ok [] to save the new name and back [] to go back to the configuration screen. Figure 7.5.7e shows the configuration screen with a renamed file and the alphanumeric keypad

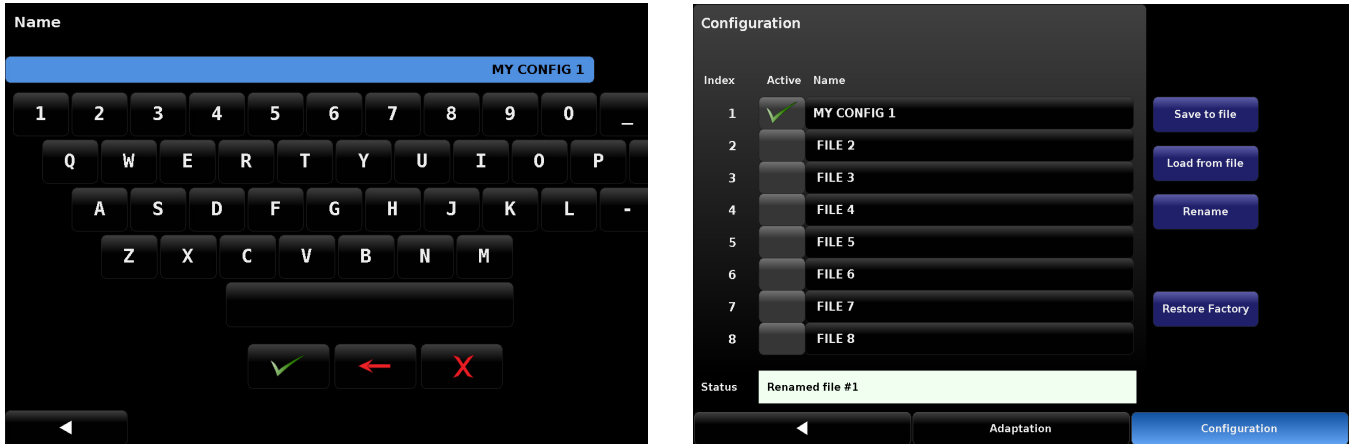



Figure 7.5.7e - Configuration screen with renamed file

To load a current adaptation test profile to a configuration file, select the configuration file by making it active [] and then pressing [Save to file] button. As shown in figure 7.5.7f, the status of the process can be seen at the status bar on the bottom of the screen. To activate a pre-saved adaptation test profile, set the desired file to active and press the [Load from file] button as shown in figure 7.5.7f.

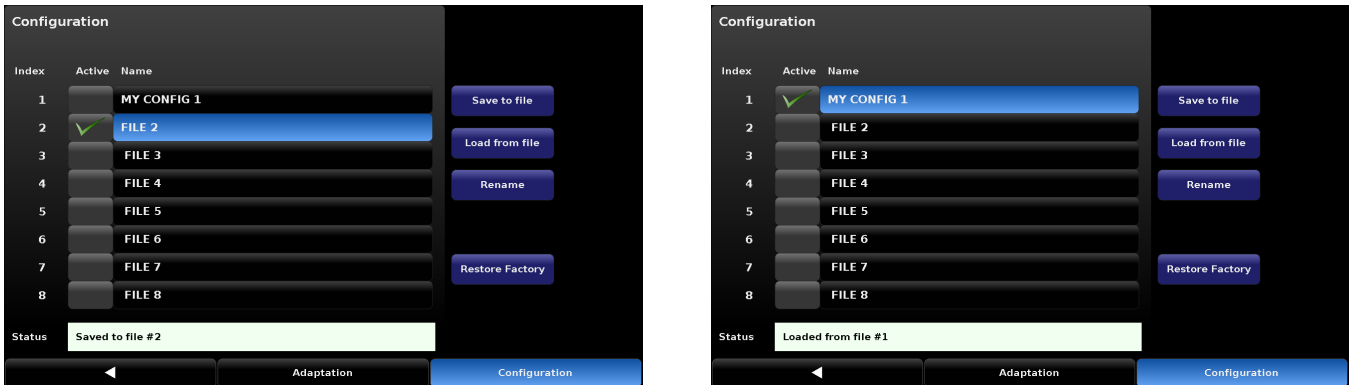

Figure 7.5.7f - Saving and loading configurations

7.6 Service Menu

7.6.1 Tune

The Tune screen is password protected and can be accessed with the service password (see section 7.5.1, Passwords).



Caution

The Setup [] / [Applications] / [Adaptation] tab and its sub tabs (Seal Point) [Characterize], [Linearity Graphs] and [Gain Test] should only be used with close supervision from Mensor Customer Service. Changing parameters within this section will change the regulator response and may cause the CPC8000 to fail to meet control specifications or output pressure that could damage externally connected instruments.



Figure 7.6.1a - Adaptation Coefficients Screen

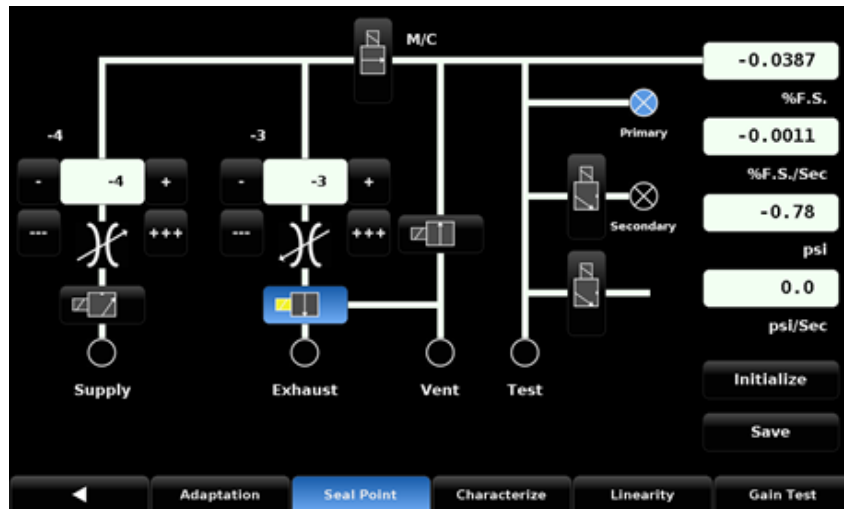

Figure 7.6.1b - Seal Point Screen

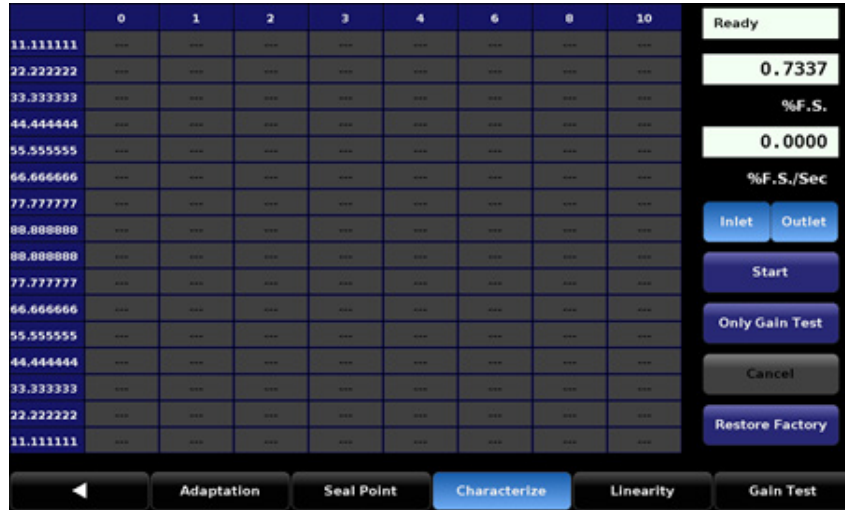

Figure 7.6.1c - Characterize Screen

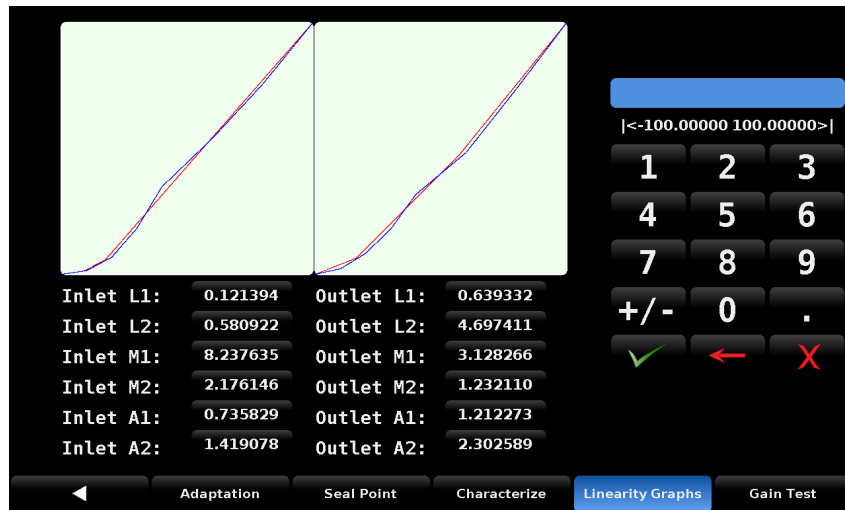

Figure 7.6.1d - Linearity Graphs Screen

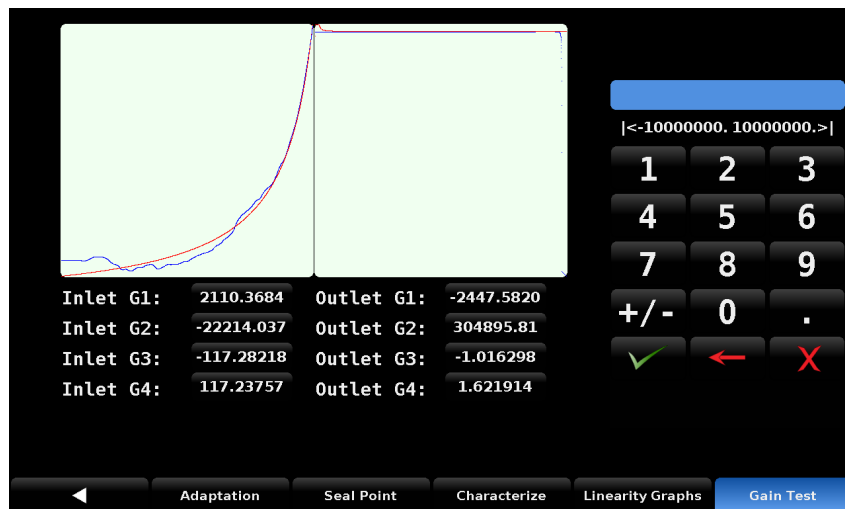



Figure 7.6.1e - Gain Test Screen showing graph for Control Adaptation

7.6.2 Admin

The Setup [] [Applications] [Admin] screen has a place to change the Calibration and Service passwords and save configurations.

7.6.2.1 Change Password

Press the [Change Password...Calibrate] button to enter a new password, and then accept by pressing the Check [] button. The same procedure applies to the [Change Password ...Service] button.

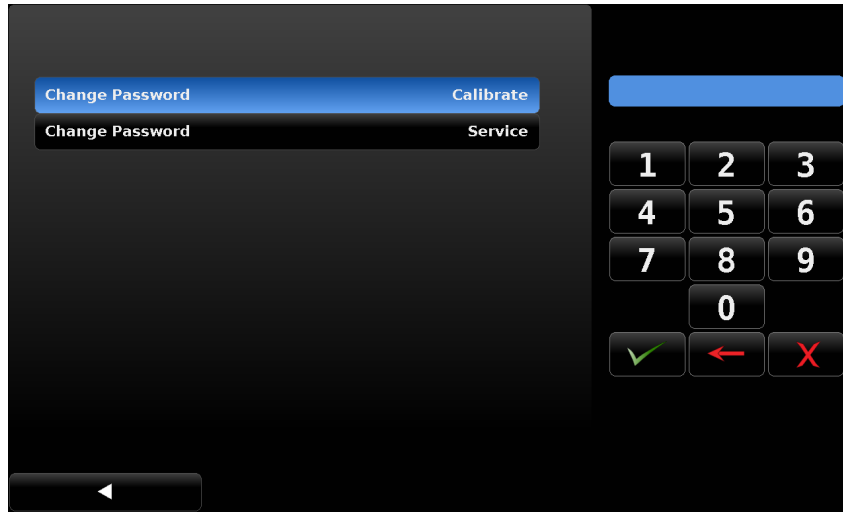

Figure 7.6.2.1 - Change Password

7.6.3 Software Upgrade

Choose the Software application [] when upgrading instrument software from a USB drive.



Figure 7.6.3 - Software

Instrument Software: Displays the current software on the controller. If you have a USB drive in the front or rear panel, you will be able to select this button. It will show you the available software versions that are on the USB drive.

Copy Programs to USB: This button will copy the programs from the CPC8000 programs application to the USB drive and store them in the root directory in a folder named “seq.” Each program will be stored within that folder as a .txt file.

Load Programs from USB: This button will load the programs that are stored on the USB drive to the CPC8000 and overwrite any current programs that are on the device.

Regulator Software: This will display the current version of regulator software. When selected, a list of regulator versions will be available for installation if they are on the USB drive.

Remove USB Device: This will safely unmount the USB drive.

Status: Displays whether or not a USB drive is available.

7.7 Info Tab

After the instrument has been powered on and the main screen is displayed press the Setup [] key and then press the [Info] tab. Information displayed will be the Mensor contact address information, the instrument's serial number, firmware version, a list of the integrated transducers and other information.



Figure 7.7 - Info Tab

8 Remote Operation

8.1 Software/Functions

When the instrument is turned on it takes about 30 seconds to complete the initialization. The BIOS routines test the system CPU board, then the operating system. The system will go through software and hardware initialization. The following hardware/software is initialized:

Transducers: The system is scanned for installed transducers and all operating transducers are initialized. The transducer(s) RAM data is transferred to system RAM where appropriate.

- GPIB: The GPIB board is initialized as a talker/listener.
- Units: The scale factors for percent full scale and counts are calculated.
- Serial: The external serial port is initialized.
- Valves: The pressure control algorithm is initialized.
- Options: Any optional hardware/software is initialized.
- Interrupts: Interrupt vectors are loaded and enabled.

After initialization, the program enters a polled loop.

The proprietary calibration constants and current settings are stored in a non-volatile device.

8.2 Remote Command Set

This remote command set is the default set available on the CPC8000. All commands must be terminated with a <CR> and/or a <LF>.

A query command ends with a ? for queries. The data column represents the response of the CPC8000. All response strings begin either with a space character or an "E" representing that there is an error in the error queue. All response strings are terminated with a <CR> and a <LF>. The error queue holds the last 10 errors identified.

Pressure readings are returned in exponential notation in a format according to the OUTFORM command as follows:

1. <sp> pressure value <cr><lf>
2. <sp> pressure, units, mode <cr><lf>
3. <sp> pressure, pressure rate <cr><lf>
4. <sp> pressure, minimum peak, maximum peak<cr><lf>
5. <sp> pressure, active sensor (P or S), active turndown (1-4)<cr><lf>
6. <sp> pressure, control point, "stable" or "slewing"<cr><lf>
7. <sp> pressure, "no barometer" or baro reading <cr><lf>

For all commands (no ?), the data column represents the required parameters to be sent to the CPC8000 following the string in the command column. Any command that requires multiple parameters must have the parameters separated by commas.

Table 8.2 - Mensor Command Set

Command/Query	Data	Function/Response
?	See Section 8.2 Remote Command Set	Returns data per the current output format.
Absolute?	<sp>YES or NO<cr><lf>	Returns if the primary transducer is native absolute
Acquire?	15 char string. Ex: Acquire? Test_stand_1 Returns: <sp>(YES or NO), CCC... CCCcr><lf>	This command is used when multiple computers would like to control the instrument. Yes if acquisition is successful. No if instrument is being controlled with another computer. CCC... = name of controlling computer. See: Release? and Unlock
Actualpress	<n>,<f>	Used for a linearity calibration fix. Sets the internal transducer's pressure for segment n. The value at segment n must be between the values of segment n-1 and n+1. End points must be within 1% of the minimum and maximum of the range's span. See "Calculate_as_found_linearity"
Actualpress? <sp><n>	<sp>+n.nnnnnE+nn<cr><lf>	Returns the actual transducer pressure for the specified segment n
Address	0-31	Sets the GPIB Address.
Address?	<sp> nn <cr><lf>	Returns the GPIB Address.
All?	<sp>+n.nnnnnE+nn,..., +n.nnnnnE+nn <cr><lf>	Returns pressure readings of all transducers on the active channel, including the barometer
Asset_tag	16 char string	General purpose string for customer use.
Asset_tag?	<sp>ssssssssssssssss<cr><lf>	Return customer asset tag string.
Autorange	ON or OFF	Sets whether the autorange function is enabled or disabled
Autorange?	<sp>(ON or OFF)<cr><lf>	Returns whether the autorange function is enabled or disabled.
Autozero	none	Re-zero all the ranges. These adjustments are not password protected and are not saved through power cycles. This command takes approximately 60 seconds but may take longer depending on the time to become stable. See Section 7.5.2.5.5, Remote Zero Calibration.
Autozero?	<sp>S,T,X,X<cr><lf>	Returns autozero data where S represents state (0 = complete, 1 = local autozero, 2 = remote autozero), T represents the estimated time to complete in seconds, and x is a (0) character since this data location is not used at this time.

Autozeroabort	none	Aborts autozero. Any transducers that have been zeroed will not revert to previous zero offsets.
Baro?	<sp>+n.nnnnnE+nn<cr><lf>	Returns reading from barometric transducer or "NO BAROMETER" if one isn't installed.
Baroid?	<sp>Mensor,SN XXXXXX, VN.NN<cr><lf>	Returns identification string for the barometer.
Barocaldisable	YES,NO	Not used, kept for backwards compatibility.
Barocaldisable?	<sp>(YES or NO)<cr><lf>	Not used, kept for backwards compatibility.
Barounits	See units code or text in Section 11.4	Sets the barometer engineering units. Note: this only effects the displayed output on the screen, not any remote responses.
Barounits?	<sp>CCCC<cr><lf>	Returns the barometer units in a text string
Brightness	0-100	Set the brightness of the screen from 0 to 100%
Brightness?	<sp>nn<cr><lf>	Get the brightness of the screen
Calculate_as_found_linearity		Calculate linearity slopes and intercepts from true/actual pressures, and loads the linearity correction coefficients to the transducer. See "ActualPress" and "TruePress".
Caldisable	YES,NO	Sets whether or not calibration of the active transducer is disabled.
Caldisable?	<sp>(YES or NO)<cr><lf>	Returns whether or not calibration of the active transducer is disabled.
Cerr	none	Clears the error queue.
Chanfunc	Press, peak, rate, rate setpt, dio, units	Sets the secondary display function mode, works identical to Chanfunc2 (kept for backwards compatibility).
Chanfunc?	<sp>CCCC...<cr><lf>	Returns the secondary alternate function mode, works identical to Chanfunc2 (kept for backwards compatibility).
Chanfunc2	Press, peak rate, rate setpt, dio, units	Sets the secondary display function mode.
Chanfunc2?	<sp>CCCC...<cr><lf>	Returns the secondary alternate function mode.
Chanfunc3	Press, peak rate, rate setpt, dio, units	Sets the tertiary display function mode.
Chanfunc3?	<sp>CCCC...<cr><lf>	Returns the tertiary alternate function mode.
Cmdset	Mensor, SCPI	Activates remote command set for instrument emulation modes.
Cmdset?	<sp><CCCCCC><cr><lf>	Returns active command set identifier.
Control		Instrument placed in Control Mode
Control?	<sp>(YES or NO)<cr><lf>	Returns YES if instrument is in control. No if otherwise.

High-End Pressure Controller CPC8000

Crate	Slow, Medium, Fast, Variable	Sets the control rate. Variable mode is a predetermined user-defined rate setpt.
Crate?	<sp>CCCCCC<cr><lf>	Returns the control rate – CCCC is variable in length and corresponds to the parameters for the CRATE command.
Ctype?		Returns the type of regulator.
Decpt?	<sp>n<cr><lf>	Returns the number of decimal points. (See Resolution)
Default	none	Sets the default values.
DHCP	ON or OFF	If no DHCP server is found when DHCP is turned on, DHCP will be turned off.
DHCP?	<sp>(YES or NO)<cr><lf>	Returns current status of DHCP.
DIO	2 or 0	2 turns on the first digital output pin, 0 turns it off.
DIO?	<sp>n<cr><lf>	Returns status of the first input and output pin. Bit0 = input's status, Bit1 = output's status.
DOUTFUNC	<n><sp>CCCCCC<cr><lf>	Sets the function for output pin <n> to NONE, STABLE, PUMP, MEASURE, CONTROL, or VENT.
DOUTFUNC? <n>	<sp>CCCCCC<cr><lf>	Returns the function for output pin <n>.
DINFUNC	<n><sp>CCCCCC	Sets the function for input pin <n> to NONE, MEASURE, CONTROL, VENT, KEYLOCK, or START.
DINFUNC? <n>	<sp>CCCCCC<cr><lf>	Returns the function for output pin <n>.
DOUTSTATE	<n><sp>HIGH/LOW/1/0	Turns output pin <n> to high or low. Sets the function for that pin to "None".
DIOSTATE?	<sp>n<cr><lf>	Bit 0-7 is the status of the input bits. Bit 8-15 are the status of the output bits. Returns an integer between 0 and 65536.
DOC	mm/dd/yyyy	Sets the date of cal for active transducer.
DOC?	<sp>mm/dd/yyyy<cr><lf>	Returns the date of cal for active transducer.
DOM?	<sp> mm/dd/yyyy<cr><lf>	Returns the date of manufacture.
Error?	<sp> text description <cr><lf>	Returns the next error in the error queue.
Errorno?	<sp>Enn-text<cr><lf>	Returns pcs400 error code and text.
Filter	Off, Low, Normal, High	Sets the reading filter 0, 80%, 92%, 95%.
Filter?	<sp> (filter)<cr><lf>	Returns the reading filter.
FilterWin	nnn	Set the filter window as a floating point value in pressure
FilterWin?	<sp>+n.nnnnnE+nn<cr><lf>	Returns the filter window
Gasdensity	Value in lb/cuft or "NITROGEN" or "DRY AIR"	Sets the head pressure gas density in lb/cuft.
Gasdensity?	<sp>+n.nnnnnE+nn<cr><lf>	Gets the head pressure gas density in lb/cuft.
Gastemp	Value in degrees F	Sets the head pressure gas temperature.

Gastemp?	<sp>+n.nnnnnE+nn<cr><lf>	Gets the head pressure gas temperature.
Gateway	nnn.nnn.nnn.nnn	Sets the Ethernet gateway address.
Gateway?	<sp>nnn.nnn.nnn. nnn<cr><lf>	Gets the Ethernet gateway address.
Gauge?	<sp>YES or NO<cr><lf>	Returns if the primary transducer is native gauge
Height	value in inches	Sets the head pressure height in inches.
Height?	<sp>+n.nnnnnE+nn<cr><lf>	Gets the head pressure height in inches.
Id?	<sp>MENSOR, CPC8000, ssssss,v.v.vv<cr><lf>	Ssssss is the serial number, v.v.vv is the CPC8000 software version.
IP	nnn.nnn.nnn.nnn	Sets the IP address of the instrument.
IP?	<sp>nnn.nnn.nnn.nnn<cr><lf>	Returns the IP address of the instrument.
Keylock	YES or NO	Locks or unlocks the entire touch screen.
Keylock?	<sp>(YES or NO)<cr><lf>	Returns Yes or No.
Language	CCCCCC	Set the active display language. Accepts the following: ENGL, ENGL US, ENGL CA, ENGL GB, GERM DE, GERM SZ, DEUT DE, DEUT SZ, FREN, FREN CA, FREN SZ, FREN CH, FRAN , FRAN CA, FRAN SZ, FRAN CH, SPAN MX, SPAN SP, SPAN LAT, SPAN AL,ESPA, ESPA MX, ESPA SP, ESPA LAT, ESPA AL, PORT, PORT PT, PORT BZ, PORT BR, ITAL, POL, RUS, CHI, JAP, KOR. Each language may also be completely spelled out, i.e. ENGLISH instead of ENGL
Language?	<sp>CCCCCC,(ABBREV)<cr><lf>	Returns the active display language, i.e. "ENGLISH (US)" or "DEUTSCH (DE)"
LLimit	nnn	Alias for "Lowerlimit". See Lowerlimit
LLimit?	<sp>n.nnnnnE+nn<cr><lf>	Alias for "Lowerlimit?". See LowerLimit?
List?	<sp>Pri,1;Sec,1;Ter,1;Bar,1<cr><lf>	Returns list of available transducers and turn-downs. Turn-downs are obsolete and therefore set to 1 for backwards compatibility.
Listcal?	<sp>PRI,{sn},1,{mmddy};SE C,{sn},1,{mmddy},TER,{sn}, 1,{mmddy},BAR,{sn},{mmdd yy}<cr><lf>	Returns list of available transducers and turn-downs' calibration dates.
Listrange?	PRI,1,min,max;SEC,1, min,max;TER,1, min,max;Bar,min,max	Returns the ranges of the installed transducers.
Localgravity	Value in ft/s^2	Sets the local gravity in feet/sec^2
Localgravity?	<sp>+n.nnnnnE+nn<cr><lf>	Returns the local gravity in feet/sec^2
Loudness	nnn	Set the speaker volume
Loudness?	<sp>n.nnnnnE+nn<cr><lf>	Returns the speaker volume from 0 to 100%
LowerLimit	nnn	Sets the lower control limit for the instrument

LowerLimit?	<sp>+n.nnnnnE+nn<cr><lf>	Returns the lower control limit for the instrument in current units.
Lowovershoot		Does not apply to the CPC8000
Lowovershoot?	<sp>YES<cr><lf>	Returns YES
Measure	None	Instrument placed in Measure Mode
Measure?	<sp>(YES or No)<cr><lf>	Returns YES if instrument is in measure. NO if otherwise
Mode	STANDBY, MEASURE, CONTROL, VENT	Sets the operation mode
Mode?	<sp>XXXXXX<cr><lf>	Returns the operation mode
Netmask	nnn.nnn.nnn.nnn	Sets the Ethernet network mask
Netmask?	<sp>nnn.nnn.nnn.nnn<cr><lf>	Gets the Ethernet network mask
NVR.ADAPTATION	<sp>(START,STOP,SLOW,FAST,CANCEL,0,1)<cr><lf>	Starts or stops controller adaption routine. Note: There is no difference between slow and fast. Both start the same controller adaptation process, and are only for backwards compatibility.
NVR.ADAPTATION?	<sp>0 to -6<cr><lf>	Returns status of controller adaption routine where the response is: 0, OK -1, active -2, leakage or no pressure supply -3, pressure supply too high or wrong mode -4, default during controller adaption -5, calculation fault -6, abandoned process
NVR.ADAPTATION.CONFIG?	<n>	Returns index, name, and status at index n. Status can be "ERROR" (no file), "INVALID" (file exists but bad data), "VALID" (valid file), or "ACTIVE" (currently active configuration)
NVR.ADAPTATION.CONFIG.ACTIVE?		Returns index, name and status of the currently active regulator configuration. (1 through 8, or factory)
NVR.ADAPTATION.CONFIG.LOAD	<n>	Load regulator configuration from file <n> to regulator board and set as active.
NVR.ADAPTATION.CONFIG.NAME	<n>,<s>	Set name of regulator configuration at index n (1...8) to string s. S may contains alpha or numeric characters or %-_.<sp>
NVR.ADAPTATION.CONFIG.NAME?	<n>	Returns name of regulator configuration at index n (1 through 8)
NVR.ADAPTATION.CONFIG.SAVE	<n>	Save regulator board's current configuration to file at index <n> and set file <n> as active.
Outform	1 to 7	Sets the output format (see Section 8.2)
Outform?	<sp>X<cr><lf>	Returns the output format

Overrange		Set the overrange percentage
Overrange?	<sp>+n.nnnnnE+nn<cr><lf>	Get the overrange percentage
Peakmax?	<sp>+n.nnnnnE+nn<cr><lf>	Returns the maximum pressure since peakreset was sent.
Peakmin?	<sp>+n.nnnnnE+nn<cr><lf>	Returns the minimum pressure since peakreset was sent.
Peakreset	None	Resets the peak values.
Port	nnnnnn	Sets the Ethernet port of the instrument
Port?	<sp>nnnnn<cr><lf>	Returns the Ethernet port of the instrument
Ptype	Absolute or Gauge	Sets the instrument pressure type. Emulation only works if the optional barometric transducer is installed.
Ptype?	<sp>CCCC<cr><lf>	Returns "GAUGE", "GAUGE EMULATION", "ABSOLUTE", or "ABSOLUTE EMULATION". Returns the current pressure type and notes if it is an emulated pressure type.
Range?	<sp>+n.nnnnnE+nn<cr><lf>	Alias for "RangeMax?". See RangeMax?
RangeMax?	<sp>+n.nnnnnE+nn<cr><lf>	Returns the maximum range of the active transducer in the current units.
RangeMin?	<sp>+n.nnnnnE+nn<cr><lf>	Returns the minimum range of the active transducer in the current units.
Rate?	<sp>+n.nnnnnE+nn<cr><lf>	Returns the rate reading of the instrument in current units/current time unit. See Runits.
Rdecpt?	<sp>n<cr><lf>	Returns the number of rate decimal points. See Resolution
Reference	{EXTVAC or ATM}	Not used, kept for backwards compatibility
Reference?	<sp>{EXTVAC or ATM}<cr><lf>	Not used, kept for backwards compatibility
Release?	15 char string. Ex: Release? Test_stand_1 Returns: <sp>(YES or NO), CCC...CCC<cr><lf>	This command is used to release control of the instrument in a multiple computer environment. Yes if release is successful No if instrument is being controlled with another computer CCC... = name of controlling computer or AVAILABLE See: Acquire? and Unlock
Resolution	<n>	Sets the number of significant digits. See decpt
Resolution?	<sp>n<cr><lf>	Returns the number of significant digits. See decpt
Rfilter	Value in %	Sets the % of the rate filter.
Rfilter?	<sp>+n.nnnnnE+nn<cr><lf>	Returns the rate filter.
RFilterWin	nnn	Set the rate filter window as a floating point value in pressure

RFilterWin?	<sp>n.nnnnnE+nn<cr><lf>	Returns the rate filter window
RStable?	YES or NO	
RStableTime	0 to 65535	Sets the rate stable time to the number of seconds specified
RStableTime?	<sp>XXXXXXX<cr><lf>	Returns the rate stable time
RStableWin	nnn	Alias for “RStableWindow”. See RStableWindow
RStableWin?	<sp>n.nnnnnE+nn<cr><lf>	Alias for “RStableWindow?”. See RStableWindow?
RStableWindow	nnn	Set the rate stable window as a %FS/second
RStableWindow?	<sp>n.nnnnnE+nn<cr><lf>	Returns the rate stable window
Rsetpt	Value in current units	Sets the rate setpoint.
Rsetpt?	<sp>n.nnnnnE+nn<cr><lf>	Returns the rate setpoint.
Runits	Sec, min, hr	Sets the rate time unit.
Runits?	<sp>XXXX<cr><lf>	Returns the rate time unit.
RLLimit	nnn	Alias for “RLowerLimit”. See RLowerLimit
RLLimit?	<sp>n.nnnnnE+nn<cr><lf>	Alias for “RLowerLimit?”. See RLowerLimit?
RLowerLimit	nnn	Set the rate lower control limit
RLowerLimit?	<sp>n.nnnnnE+nn<cr><lf>	Returns the rate lower control limit
RULimit	nnn	Alias for “RUpperLimit”. See RUpperLimit
RULimit?	<sp>n.nnnnnE+nn<cr><lf>	Alias for “RUpperLimit?”. See RUpperLimit?
RUpperLimit	nnn	Set the rate upper control limit
RUpperLimit?	<sp>n.nnnnnE+nn<cr><lf>	Returns the rate upper control limit
Rwindow	Value in current units	Sets rate exponential filter window
Rwindow?	<sp>n.nnnnnE+nn<cr><lf>	Returns rate exponential filter window
Save_cal		Save calibration values.
Save_linearity		Save linearity values.
Sbaud	9600, 19200, 38400, 57600, 115200	Sets the serial baud rate.
Sbaud?	<sp>XXXX<cr><lf>	Returns the serial baud data.
Sdata	7 or 8	Sets the serial data bits.
Sdata?	<sp>n<cr><lf>	Returns the serial data bits number.
Sensor	1, 2, 3, or PRIMARY, SECONDARY, TERTIARY	Sets the active transducer.
Sensor?	<sp>XXXXXXX,1<cr><lf>	Returns active transducer in long string format.
Sensorid?	<sp><sensor#><sp>ID<sp>MENSOR,<sp><model>,<sp><SN>,<sp>V<version><cr><lf>	Returns the active transducer’s serial number and firmware version.

Setpoint	nnn.nnn	Sets the control setpoint for the instrument. Value must be inside upper and lower limits. Alias for "Setpt"
Setpoint?	<sp>nnn.nnnnE+nn<cr><lf>	Returns the control setpoint in current units
Setpoint%	nnn.nnn	Sets the control setpoint in %FS of primary transducer range
Setpoint%?	<sp>nnn.nnnnE+nn<cr><lf>	Returns the current setpoint in % of primary transducer range. Alias for "Setpt%?"
Setpt	nnn.nnn	Sets the control setpoint for the instrument. Value must be inside upper and lower limits
Setpt?	<sp>+n.nnnnnE+nn<cr><lf>	Returns the control setpoint in current units.
Setpt%	nnn.nnn	Sets the control setpoint in % of current range.
Setptpct	nnn.nnn	Sets the control setpoint in % of current range.
Setptpct?	<sp>+n.nnnnnE+nn<cr><lf>	Returns the current setpoint in % of current range.
Span	nnn.nnn (Desired pressure value)	Sets span on active transducer or for ?, clears previous value, must be > 50% FS and has a 1% limit. CALDISABLE must be OFF/NO.
Span?	<sp>+n.nnnnnE+nn<cr><lf>	Returns span scale factor for active transducer.
Sparity	Even, ODD, NONE	Sets the serial parity.
Sparity?	<sp>CCCC<cr><lf>	Returns the serial parity.
Srqmask	Stable,Error or both	Sets the CPC8000 to issue a service request (SRQ) over the IEEE when the pressure control is stable, or an error occurs. These are 80 hex and 40 hex respectively.
Srqmask?	<sp>{string}<cr><lf>	Returns "stable", "error" or "error, stable" depending on the SRQ.
Sstop	1 or 2	Sets the serial stop bits.
Sstop?	<sp>X<cr><lf>	Returns the serial stop bits.
Stable?		Returns YES if instrument is stable, or NO.
Stabledelay	0 to 65535	Sets the stable time to the number of seconds specified.
Stabledelay?	<sp>XXXXXXX<cr><lf>	Returns the stable time.
Stabletime	0 to 65535	Sets the stable time to the number of seconds specified.
Stabletime?	<sp>+n.nnnnnE+nn<cr><lf>	Returns the stable time.
StableWin	nnn.nnn	Sets the stable window as a %FS.
StableWin?	<sp>+n.nnnnnE+nn<cr><lf>	Returns the stable window.
Standby	None	Instrument placed in Standby mode

Standby?	<sp>(YES or NO)<cr><lf>	Returns YES if instrument is in Standby, NO if otherwise
Step	Value inside upper and lower limits and inside the range of the active transducer	Sets the control step size for the instrument
Step-		Jogs the setpoint down one step
Step+		Jogs the setpoint up one step
Step?	<sp>+n.nnnnnE+nn<cr><lf>	Returns the control step for the instrument
Step%	Value in % of current range	Sets the control step in % of current range
Steppct	Value in % of current range	Sets the control step in % of current range
Steppct?	<sp>+n.nnnnnE+nn<cr><lf>	Returns the current step in % of current range
Subunits		Sets engineering units in Auxiliary Display 1. See units text in Section 11.4
Subunits?	<sp>CCCC<cr><lf>	Returns Auxiliary Display 1 engineering units in a text string.
Subunits2		Sets engineering units in Auxiliary Display 2. See units text in Section 11.4
Subunits 2?	<sp>CCCC<cr><lf>	Returns Auxiliary Display 2 engineering units in a text string.
Tare	ON or OFF	Tares current reading to zero. The same tare value is applied to all measuring transducers.
Tare?	<sp>+n.nnnnnE+nn<cr><lf>	Returns the tare value applied to all transducers in current units.
Termchar	CCC	Set the termination character for the active command set (for example the Mensor command set will be different from the SCPI command set). Accepts the following: CRLF, CR, LF, EOI, NONE, DEFAULT
Termchar?	<sp>CCCC<cr><lf>	Returns the termination character.
Timeouten	ON or OFF	Enables the Ethernet timeout
Timeouten?	<sp>(YES or NO)<cr><lf>	Returns the Ethernet timeout state
Timeoutsec	nnn	Set the Ethernet timeout in seconds, to automatically close the socket if no activity has occurred. The default is 172800 seconds (2 days).
Timeoutsec?	<sp>nnnnnnn<cr><lf>	Returns the Ethernet timeout in seconds
Touchcal		Start the touchscreen calibration process
Truepress	<n>,<f>	Used for a linearity calibration fix. Sets the internal transducer's pressure for segment n. The value at segment n must be between the values of segment n-1 and n+1. End points must be within 1% of the minimum and maximum of the range's span. See "Calculate_as_found_linearity"
Truepress?<sp><n>	<sp>+n.nnnnnE+nn<cr><lf>	Returns the reference pressure for the specified segment n

Units	See units code or text in Section 11.4	Sets the instrument engineering units. .
Units?	<sp>CCCC<cr><lf>	Returns the instrument units in a text string
Unitbase1	See units code or text in Section 11.4	Sets the user 1 base engineering units. Options are psi, bar, pascal.
Unitbase1?	<sp>CCCC<cr><lf>	Returns the user 1 base units in a text string
Unitbase2	See units code or text in Section 11.4	Sets the user 2 base engineering units. Options are psi, bar, pascal.
Unitbase2?	<sp>CCCC<cr><lf>	Returns the user 2 base units in a text string
Unitfact1	Multiplier factor	Sets the user 1 unit multiplier
Unitfact1?	<sp>n.nnnnnE+nn<cr><lf>	Returns the user 1 unit multiplier
Unitfact2	Multiplier factor	Sets the user 2 unit multiplier
Unitfact2?	<sp>n.nnnnnE+nn<cr><lf>	Returns the user 2 unit multiplier
ULimit	nnn	Alias for "Upperlimit". See Upperlimit
ULimit?	<sp>xxxxxx<cr><lf>	Alias for "Upperlimit?". See Upperlimit?
Unlock	None	Releases Acquire locks See Acquire? And Release?
UpperLimit	nnn	Sets the upper control limit for the active transducer.
UpperLimit?	<sp>+n.nnnnnE+nn<cr><lf>	Returns the upper control limit for the active transducer.
Vent	None	Instrument placed in Vent Mode
Vent?	<sp>(YES or NO)<cr><lf>	Returns YES if instrument is in Vent, NO if otherwise
Vent_Limit	nnn	Set the pressure where the vent valve will open completely during a controlled vent
Vent_Limit?	<sp>+n.nnnnnE+nn<cr><lf>	Returns the vent limit in current units.
Vent_Rate	nnn	Set the controlled vent rate
Vent_Rate?	<sp>+n.nnnnnE+nn<cr><lf>	Returns the vent rate in current units.
WID?	<sp>MENSOR,WIKASN,X. XX.XX<cr><lf>	Returns manufacturer, instrument's Wika serial number, instrument software version number
Window	Value in current units	Sets the exponential filter window for the active transducer
Window?	<sp>+n.nnnnnE+nn<cr><lf>	Returns the exponential filter window for the active transducer
Zero	desired pressure or ?	Sets zero to set pressure or for ?, clears previous value. CALDISABLE must be OFF/ NO. See Section 7.5.2.5.5, Remote Zero Calibration.
Zero?	<sp>+n.nnnnnE+nn<cr><lf>	Returns zero offset for active transducer

8.3 SCPI WIKA Command Set

Table 8.3 - SCPI Commands

Command or Query	Response/Function
MEASure	
[:PRESsure] [R]?	Returns the pressure from range R.
:TEMPerature[R]?	Returns the temperature from range R.
:RATE[R]?	Returns the pressure rate/sec from range R.
:BAROmetric?	Returns the barometric pressure.
CALibration	
[:PRESsure][R]	
:MODE?	Returns 1=calibrated or 0=not calibrated.
:DATE?	Returns date of cal “MM/DD/YY”
:DATE <i,i,i>	Sets date of cal YYYY,MM,DD
:ZERO?	Returns zero offset.
:ZERO <n>	Sets the zero offset. (See Section 7.5.2.5.5, Remote Zero Calibration).
:ZERO:RUN	Start autozero sequence. (See Section 7.5.2.5.5, Remote Zero Calibration).
:ZERO:STOP	Stop autozero sequence
:ZERO:INITiate?	Returns zero status
:ZERO:INITiate	Ignored
SENSe	
[:PRESsure] [R]	
:NAME?	Returns transducer name string.
:MODE?	Returns pressure type “ABSOLUTE” or “GAUGE”
:MODE ABS GAUGE	Sets the pressure type to absolute or gauge.
:ABS?	Returns native transducer type “1” for absolute, ”0” for gauge.
:RESolution?	Returns resolution (float).
:RANGe	
[:UPPer]?	Returns the maximum range.
:LOWer?	Returns the minimum range.
:Unit	
[:NAME]?	Returns ASCII units (mixed case).
:VALue?	Returns the units conversion factor.
:REFerence	
[:HEIGHt] <n>	Sets the head pressure height.
:HEIGHt?	Returns the head pressure height.
:MODE?	Returns “OFF”, “GAS”, or LIQUID”.
:MODE OFF GAS LIQUID	Sets the head pressure mode.

:MEDium<n>	Sets the medium density.
:MEDium?	Returns medium.
:ACTive <n>	Sets the active transducer
:ACTive?	Returns the active transducer
SYSTem	
:DATE <i,i,i>	Not used, kept for backwards compatibility
:DATE?	Not used, does not cause an error, does not return a response.
:TIME <i,i,i>	Not used, kept for backwards compatibility
:TIME?	Not used, does not cause an error, does not return a response.
:ERRor[:NEXT]?	Return error code, description.
:KLOCK ON OFF 1 0	Sets the keylock state.
:PRESet	Load default values.
:SAVE	no function (not needed).
:VERsion?	Return SCPI version 1994.0.
TEST	
:ELECTronic?	Returns "OK".
:RELay <n>?	Returns status of digital output <n>.
:RELay <n> ON OFF	Turns the digital output on or off <n>.
UNIT	(Note: see Table 11.1 Measurement Units)
:NAME <n>?	Returns the units string for units code <n>.
:FACTor <n>?	Returns the units conversion for units code <n>.
[:PRESsure] bar mbar Palpsi	Sets the pressure units.
[:PRESsure]?	Returns the pressure units.
:USER	
:FACTOR <n>, <f>	Sets the multiplier to <f> for user unit <n>
:FACTOR ? <n>	Returns the multiplier <f> for user unit <n>
:BASE <n>, <s>	Sets the base engineering units for user unit <n>, options are psi, bar, pascal.
:BASE? <n>	Returns the base engineering units for user unit <n> as a text string

:INDEX <n>	Sets the global remote unit by index number.																																										
:INDEX?	Returns the index number. <table border="1"> <thead> <tr> <th>Index</th> <th>Unit</th> </tr> </thead> <tbody> <tr><td>0</td><td>bar</td></tr> <tr><td>1</td><td>mbar</td></tr> <tr><td>2</td><td>Pa</td></tr> <tr><td>3</td><td>psi</td></tr> <tr><td>4</td><td>atm</td></tr> <tr><td>5</td><td>kp/cm²</td></tr> <tr><td>6</td><td>lbf/ft²</td></tr> <tr><td>7</td><td>kPa</td></tr> <tr><td>8</td><td>cmH₂O(4°C)</td></tr> <tr><td>9</td><td>inH₂O(4°C)</td></tr> <tr><td>10</td><td>inH₂O(20°C)</td></tr> <tr><td>11</td><td>inH₂O(60°F)</td></tr> <tr><td>12</td><td>ftH₂O(4°C)</td></tr> <tr><td>13</td><td>mmHg(0°C)</td></tr> <tr><td>14</td><td>cmHg(4°C)</td></tr> <tr><td>15</td><td>inHg(0°C)</td></tr> <tr><td>16</td><td>inHg(60°F)</td></tr> <tr><td>17</td><td>% of range</td></tr> <tr><td>18</td><td>user units 1</td></tr> <tr><td>19</td><td>user units 2</td></tr> </tbody> </table>	Index	Unit	0	bar	1	mbar	2	Pa	3	psi	4	atm	5	kp/cm ²	6	lbf/ft ²	7	kPa	8	cmH ₂ O(4°C)	9	inH ₂ O(4°C)	10	inH ₂ O(20°C)	11	inH ₂ O(60°F)	12	ftH ₂ O(4°C)	13	mmHg(0°C)	14	cmHg(4°C)	15	inHg(0°C)	16	inHg(60°F)	17	% of range	18	user units 1	19	user units 2
Index	Unit																																										
0	bar																																										
1	mbar																																										
2	Pa																																										
3	psi																																										
4	atm																																										
5	kp/cm ²																																										
6	lbf/ft ²																																										
7	kPa																																										
8	cmH ₂ O(4°C)																																										
9	inH ₂ O(4°C)																																										
10	inH ₂ O(20°C)																																										
11	inH ₂ O(60°F)																																										
12	ftH ₂ O(4°C)																																										
13	mmHg(0°C)																																										
14	cmHg(4°C)																																										
15	inHg(0°C)																																										
16	inHg(60°F)																																										
17	% of range																																										
18	user units 1																																										
19	user units 2																																										
OUTPUT																																											
:STATe ON/OFF/1/0	ON or 1 = Control OFF or 0 = Measure.																																										
:STATe?	Returns 0 for measure 1 for control.																																										
:MODE MEASure/CONTrol/VENT	Sets the mode indicated.																																										
:MODE?	Returns the mode string.																																										
:STABle?	Returns 1 if stable 0 if not.																																										
:AUTOvent ON/OFF/1/0	Autovent causes the controller to vent when a setpt of 0 is sent while in gauge or gauge emulation.																																										
:AUTOvent?	Returns the autovent state.																																										
:AUTORange ON/OFF/1/0	Turns autorange on or off.																																										
:AUTORange?	Returns "ON" or "OFF".																																										
SOURCE																																											
[:PRESsure]																																											
[:LEVel]																																											
[:IMMediate]																																											
[:AMPLitude] <n>	Sets the setpoint.																																										
[:AMPLitude]?	Returns the setpoint.																																										
:SLEW <n>	Sets the slew rate setpoint in %FS/sec.																																										
:SLEW?	Returns the slew rate setpoint.																																										
:TOLerance <n>	Sets the stable window in %FS.																																										
:TOLerance?	Returns the stable window in %FS.																																										
CALCulate																																											
:LIMit																																											
:LOWer <n>	Sets minimum control limit.																																										
:LOWer?	Returns minimum control limit.																																										

:UPPer<n>	Sets maximum control limit.
:UPPer?	Returns maximum control limit.
:VENT <n>	Pressure at which the vent solenoid opens for an uncontrolled vent.
:VENT?	Returns the pressure at which the vent solenoid opens.
:VRATE	Sets the rate at which the controlled vent goes to atmosphere.
:VRATE?	Returns the rate at which the controlled vent goes to atmosphere.
:SYSTem	
:DETECT SLOW/FAST/CANCEL	Starts or stops controller adaption routine. Note: There is no difference between slow and fast. Both start the same controller adaptation process, and are only for backwards compatibility.
:DETECT?	Returns status of controller adaption routine where the response is: 0, OK -1, active -2, leakage or no pressure supply -3, pressure supply too high or wrong mode -4, default during controller adaption -5, calculation fault -6, abandoned process
:TARE	
:STATe ON/OFF/1/0	Tare the current reading. The same tare value is applied to all measuring transducers.
:STATe?	Returns the tare value.

8.4 SCPI Error Messages and Error Codes

When an error occurs, the error icon in the lower right hand corner of the main screen turns yellow and becomes a button. When pressed, the error log is shown and all errors are cleared. Note, going to the error log will put the instrument in measure mode for safety reasons. Error -500 is a pneumatics error whose message will be different depending on the pneumatic error. Error 999 is a general purpose error which couldn't be categorized in the pre-defined errors.

Table 8.4 - Error Codes SCPI

Code	Error String Returned
0	No error
-101	Undefined character
-102	Syntax error
-103	Undefined separator
-104	Parameter data type error
-109	Parameter missing
-110	Undefined header
-113	Undefined command
-114	Parameter out of range
-313	Calibration data not found
-315	Configuration data not found
-350	Errorqueue overflow
-410	Query interrupted
-500	Regulator error message
600	Default configuration not found
601	Calibration mode active! Deactivate before setting C0..C3
602	Sensor not available
701	DCS instance not available
702	Create DCS instance failed
703	DCS still active
704	Command currently not allowed
999	General purpose error message

8.5 Command Emulation

8.5.1 PCS 400 Emulated Commands

Table 8.5 - PCS 400 Emulated Commands

Command	Data	Response/Function
_pcs4 autorange <value>	0 or 1	1 turns autorange on, 0 = off
_pcs4 autorange?		Returns 1 if in autorange, 0 if in range hold
_pcs4 cal a/d		Not used, kept for backwards compatibility
_pcs4 cal atm		Performs pcs400 1 pt cal
_pcs4 cal span <value>		Sets the span of the active transducer to <value>
_pcs4 cal zero <value>		Sets the zero of the active transducer to <value>
_pcs4 cal_disable_off		Enables zero or span calibrations if previously disabled.
_pcs4 cal_disable_on		Prevents zero or span calibrations
_pcs4 ctrl <value><sp><unitno>		Sets control value – will take effect immediately if instrument is in control mode.
_pcs4 ctrl?		Returns the current control point in current engineering units.
_pcs4 ctrlmax<value>		Sets maximum control value.
_pcs4 ctrlmax?		Returns current maximum control pressure.
_pcs4 ctrlmin<value>		Sets minimum control value.
_pcs4 ctrlmin?		Returns current minimum control pressure.
_pcs4 emul?		Returns ptype emulation mode
_pcs4 default		Sets default values into instrument.
_pcs4 err?		Returns the error number and description.
_pcs4 exhaustp?		Returns exhaust pressure
_psc4 filtersetting		Sets the filter %
_pcs4 filtersetting?		Returns the filter %
_pcs4 filterwindow		Sets the filter window
_pcs4 filterwindow?		Returns the filter window
_pcs4 func ctrl <value><unitno>		Instrument placed in control mode at <value> pressure in <unitno> units.
_pcs4 func emul		Toggles ptype emulation mode
_pcs4 func F1		Toggles ptype emulation mode
_pcs4 func meas		Instrument placed in measure mode.
_pcs4 func stby <unitno>		Instrument placed in standby mode in <unitno> units
_pcs4 func vent <unitno>		Instrument placed in vent mode in <unitno> units
_pcs4 id?		Returns instrument ID.
_pcs4 lang PCS2		Sets command set to PCS 200
_pcs4 list?		Returns range list
_pcs4 opt?		Returns option list (old pcs400 format)
_pcs4 option?		Returns option list.

High-End Pressure Controller CPC8000

_pcs4 outform<digit>		Sets output format.
_pcs4 outform?		Returns the current output format.
_pcs4 peakreset		Resets peak readings
_pcs4 peakunit		Selects Peak+ or Peak-
_pcs4 peakunit?		Returns Peak+ or Peak-
_pcs4 rangemax?		Returns the max. pressure of the active transducer.
_pcs4 rangemin?		Returns the min. pressure of the active transducer.
_pcs4 rate		Sets the control rate
_pcs4 rate?		Returns the pressure rate
_pcs4 rateunit		Selects the rate units (SEC or MIN)
_pcs4 rateunit?		Returns the rate units
_pcs4 reading?		Returns the current pressure
_pcs4 sourcep?		Returns the supply pressure
_pcs4 span?		Returns the stored multiplication factor from the active transducer & turndown.
_pcs4 stabledelay<value>	1 to 255	Sets the number of consecutive readings that the pressure must remain within the stable window for a pressure stable indication.
_pcs4 stabledelay?		Returns the number of readings that must be within the stable window before a stable pressure is indicated.
_pcs4 stablewindow<value>		Sets the pressure window that is used to indicate pressure is stable.
_pcs4 stablewindow?		Returns the pressure tolerance allowed for a stable pressure indication as a % of span of the active transducer.
_pcs4 stat?		Returns Mode and stable flag status "mode, stable CR LF"
_pcs4 unit <unitno>		Sets the instrument to specified engineering units
_pcs4 unit?		Returns the current engineering units and the type of transducer (A, G, D)
_pcs4 xducer?		Returns the number of the currently active transducer.
_pcs4 xducerid?		Returns the internal transducer number, serial number, min and max transducer range.
_pcs4 zero?		Returns the stored zero offset of the active transducer and turndown in the current pressure units.

9 Options

This section lists options available for the CPC8000. Users might consider letting the factory install a special feature not listed here. Mensor welcomes the opportunity to quote on such requests. The cost of adding an enhancement frequently will amortize itself in a very short time because of improved process efficiency.

9.1 Transport Case

A wheeled transport case is available suitable for moving the CPC8000 between sites, or as an air-freight (or other) shipping container. The case is constructed of a high impact plastic with a black exterior. It includes two keys, locks, a piano hinge, an anodized interlocking tongue and groove opening, various nickel-chrome and stainless steel fixtures, a vinyl satchel style handle and a retractable pull-out handle. The interior is filled with high density polyurethane foam with a die-cut cavity to cradle the instrument with fitting adapters in place, and an additional cavity to store related accessories. Rugged and weather resistant, the case makes an attractive, practical shipping and moving container. The case weighs approximately 29 pounds (13.15 kg) unloaded, and can support a load of up to 150 pounds (68.04 kg). Nominal dimensions are 15 inches by 24 inches by 26 inches (38.10 cm x 60.96 cm x 66.04).

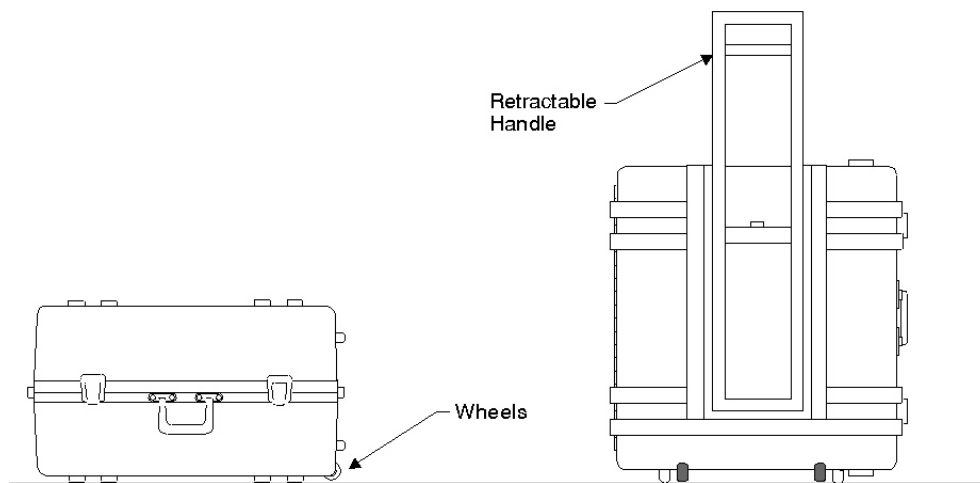

Figure 9.1 - Transport Case

9.2 Rack Mount Kit

This kit provides the materials and instructions necessary for the user to convert a desk top CPC8000 for installation into a standard 19" rack.

9.3 Barometric Reference Transducer

This optional transducer allows gauge mode instruments to operate in absolute mode, and similarly, absolute mode instruments to operate in gauge mode. Changing modes is easily accomplished from the front panel or over the remote interface.

In use the active channel of the CPC8000 will either add or subtract the measurement of the installed barometric reference transducer to accomplish the appropriate emulation.

9.4 Model 75 Pressure Booster System

To control pressure, the CPC8000 requires a pressure supply of 10% above the full scale of the instrument. For ranges of 3000 psi or greater, this is above the typical gas bottle/cylinder. The Model 75 Pressure Booster System provides the ability to boost bottle pressure up to the supply pressure requirements of all possible CPC8000 range configurations while maximizing gas bottle/cylinder usage.

The Model 75 is a single piston air driven gas booster mounted in a heavy duty roll bar frame. The unit includes an operator control panel with gauges for supply pressure, output reference pressure and an output vent valve. The system requires shop air to drive the booster and a minimum of 300 psi to 3000 maximum inlet pressure (clean dry air or Nitrogen).

Table 9.4 - Specifications for Input Supply Pressure and Output Pressure

Input Supply Pressure	Minimum: 300 psi Maximum: 3000 psi Media: Clean Dry Inert Gas (Nitrogen preferred)
Output Pressure	6500 psi typical 7000 psi relief valve setting

Please refer to the Model 75 data sheet (CDS075) for additional information and specifications, available on our web site at www.mensor.com.

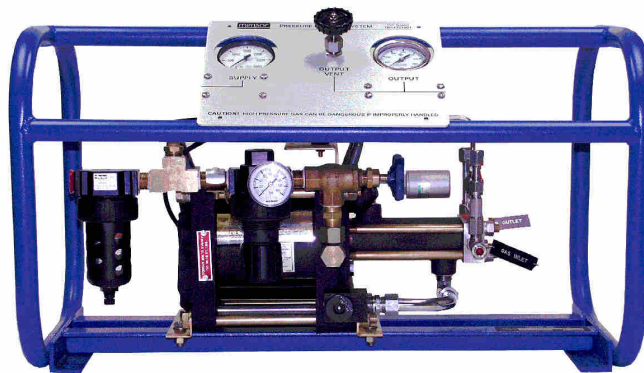

Figure 9.4 - Model 75 Pressure Booster System

10 Maintenance

The CPC8000 was designed for maintenance-free operation. User maintenance is not recommended. If you have questions not covered by this manual, call 1-800-984-4200 (USA only), or 1-512-396-4200 for assistance or send an email to tech.support@mentor.com.

10.1 Beyond the Warranty

Take advantage of Mensor's expert product care. Mensor provides complete maintenance and calibration services, available for a nominal fee. Our service staff is knowledgeable in the innermost details of all of our instruments. We maintain units that are in operation in many different industries and in a variety of applications, and by users with a wide range of requirements. Many of our instruments have been in service for decades, and continue to produce excellent results.

Returning your instrument to Mensor for service benefits you in several ways:

- Our extensive knowledge of the instrument assures you that it will receive expert care.
- In many cases we can economically upgrade an older instrument to the latest improvements.
- Servicing our own instruments which are used in "real world" applications keeps us informed as to the most frequent services required. We use this knowledge in our continuing effort to design better and more robust instruments.

10.2 Troubleshooting



ESD PROTECTION REQUIRED! The proper use of grounded work surfaces and personal wrist straps are required when coming into contact with exposed circuits (printed circuit boards) to prevent static discharge damage to sensitive electronic components.





Warning

WARNING! If faults cannot be corrected locally, immediately take the system off line and protect it from unintentional restarts. Contact Mensor Customer Service for further instructions. Apparent problems are frequently resolved over the telephone by our staff.

Do not risk voiding the warranty. Higher level repairs must be carried out exclusively by Mensor authorized personnel, or under Mensor supervision.

Servicing of electrical, electronic, pneumatic or hydraulic equipment must be performed by qualified and authorized technical staff, observing all relevant safety regulations.

Table 10.2 - Troubleshooting

Type	Problem	Correction Action
1	The system has been switched on and no measurement(s) have appeared and the entire area of the screen is white (or dark).	Switch the system off. Wait 5 seconds and switch the system on.
2	The screen is dark and the corrective action for #1 above has no effect	Check that the power cable is connected properly and have authorized technical staff check that the supply voltage is correct.
3	The screen is dark and the action taken to solve the problem of #2 above has no effect.	<p>Unplug the unit from the power source (wall socket), then remove the power cord from the instrument. The power cord input socket includes two internal fuses. Check both fuses for continuity.</p>  <p style="text-align: center;">Power cord input socket</p>  <p>WARNING! When needed, use only 2.5 amp 250V SLO-BLO 5x20 Fuse</p>
4	Malfunction during operation.	Switch the system off. Wait 5 seconds and switch the system on.
5	Unstable control.	Consult factory
6	The setpoint value is not reached.	Check whether the value of the supply pressure is the value required, and leak test the plumbing.

If you need help or assistance, contact Mensor at

Phone: 1-512-396-4200 or 1-800-984-4200 (USA only)

Fax: 512-396-1820

Email: sales@mensor.com

tech.support@mensor.com

Website: www.mensor.com

10.2.1 Pressure Transducer Location

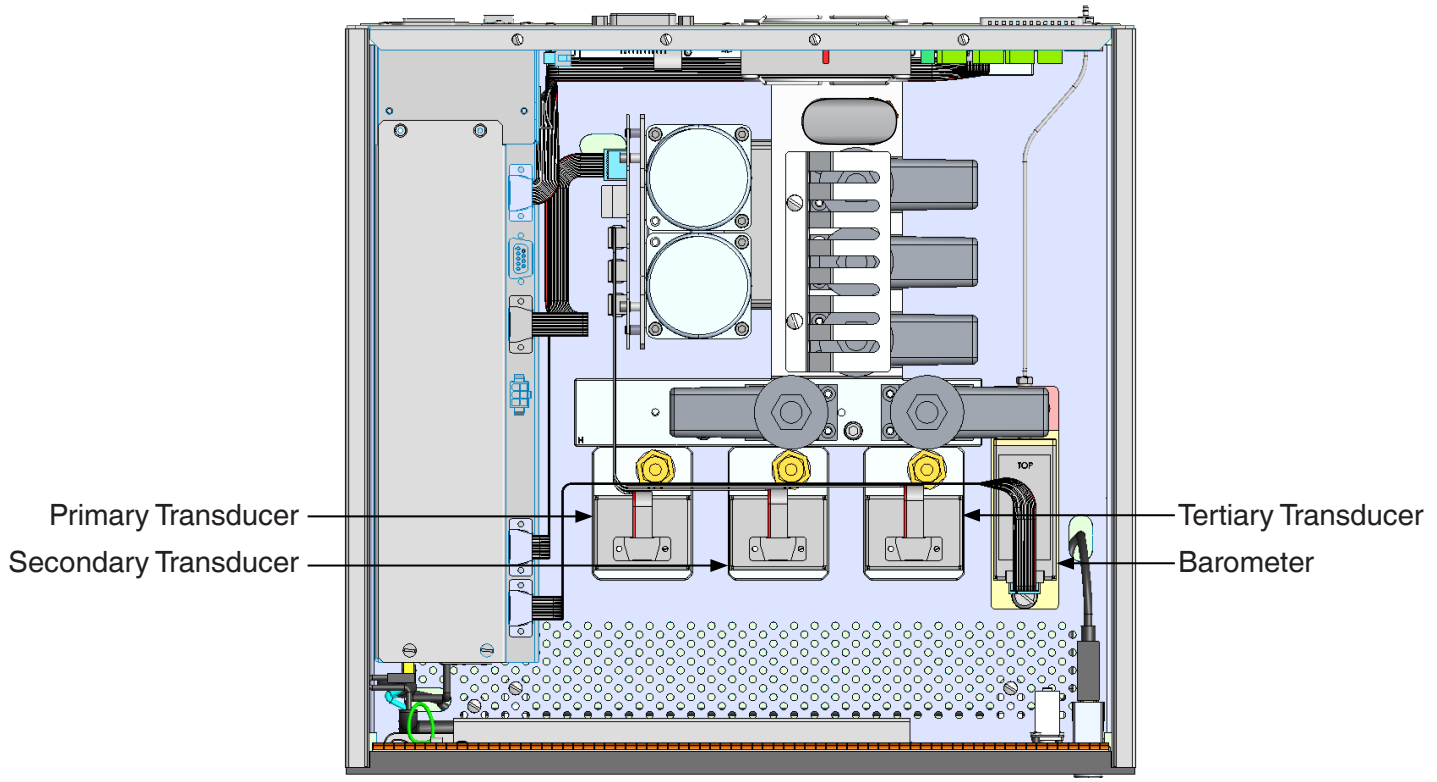

Figure 10.2.1 - Top View

10.2.2 Transducer Removal / Replacement

The front panel is hinged to allow access to the self-contained pressure transducers. To open the front panel, first turn off system power, then loosen the two (captive) screws near the right hand edge of the panel. The panel can then swing away to reveal the transducers lined up across the interior.



Notice

If the system has not been powered down, opening the front panel will trip an interlock to vent the system to atmosphere.



CAUTION: Further access to the interior of the instrument is NOT recommended. There are no user-serviceable plumbing or parts inside. In addition to the dangerous voltages present (line voltage), there are circuits sensitive to electrostatic discharge damage.

To remove a transducer from the system, swing the front panel open and disconnect the 9-pin D-sub connector from its top. Then use the supplied 3/16 inch Allen wrench to loosen the two cap screws near the base of the transducer. With both screws disengaged, slide the transducer toward the front opening to disconnect it from the manifold. If an optional Barometric transducer is present it will occupy a slot to the far right and will be secured in place with a thumb screw. Loosen the thumb screw and lift the transducer up and over the retaining pin. Each pressure or barometer module is totally self-contained and including the pressure transducer and all of its calibration data.

To return the module, or a replacement module to the system slide it firmly back into position to engage the pneumatic passages with those in the manifold, tighten the two retaining cap screws, and connect the communication/power D-sub connector. To replace the optional barometer, slide it back into place over the retaining pin and tighten the thumb screw. Finally, secure the front panel and test that the system is operational.

In replacing transducer modules the order of position must be maintained according to the pressure limit of each module; starting with the highest pressure transducer on the left (PRIMARY TRANSDUCER), and the next lower pressure limit transducer next (SECONDARY TRANSDUCER), and the lowest ranged transducer to the right (TERTIARY TRANSDUCER). If an optional BAROMETRIC TRANSDUCER is present it will occupy a different type slot to the right of the TERTIARY TRANSDUCER.

If the system will be operated with less than the full complement of three pressure modules (not including the BAROMETRIC TRANSDUCER) the first empty slots must be the TERTIARY TRANSDUCER Slot. If there is just one installed transducer then the SECONDARY TRANSDUCER slot would also be empty. To be functional, each empty slot must have a pneumatic seal on the manifold. In this case a manifold seal plate is supplied and attached at the Mensor factory for this purpose. The D-sub connectors for unused slots can remain unplugged.

10.2.3 Side Panel Removal

On desk-top units the two identical side panels include formed recesses which are used as lift points to move or carry the instrument over short distances. These side panels are secured to the chassis by three 3mm Allen cap screws accessible inside the lift-recesses. With the cap-screws removed pull the side panel straight out away from the chassis with enough force to overcome the friction pins which hold it in position.

11 Appendix

11.1 Measurement Units

The Units command selects the measurement units to be output on the bus and the display.

Table 11.1 - Measurement Units

Description	Output format
psi	psi
bar	bar
millibar	mbar
hectopascals	hPa
kilopascals	kPa
kilogram per centimeter squared	kg/sq cm
inches of mercury @0 degrees Celcius	inHg @0C
inches of water @4 degrees Celcius	inH2O @4C
inches of water @20 degrees Celcius	inH2O @20C
inches of water @60 degrees Ferenheit	inH2O @60F
feet of water @4 degrees Celcius	ftH2O @4C
feet of water @20 degrees Celcius	ftH2O @20C
feet of water @60 degrees Ferenheit	ftH2O @60F
millimeters of mercury @0 degrees Celcius	mmHg @0C
millimeters of water @4 degrees Celcius	mmH2O @4C
millimeters of water @20 degrees Celcius	mmH2O @20C
centimeters of mercury @0 degrees Celcius	cmHg @0C
centimeters of water @4 degrees Celcius	cmH2O @4C
centimeters of water @20 degrees Celcius	cmH2O @20C
ounce per square inch	oz/si
psf	psf
tons per quare inch	tons/sq in
tons per square foot	tons/sq ft
inches of sea water	inSW
feet of sea water	ftSW
inches of mercury @ 60 degrees Feihrenheit	inHg @60F
torr	Torr
millitorr	mTorr
microns of mercury @0 degrees Celcius	micronHg @0C
millimeters of mercury @0 degrees Celcius	mmHg @0C
centimeters of mercury @0 degrees Celcius	cmHg @0C
meter of mercury @0 degrees Celcius	mHg 0C
meters of water @20 degrees Celcius	mH2O @20C
meters of water @4 degrees Celcius	mH2O @4C

meters of sea water	mSW
grams per centimeter squared	g/cm ²
kilogram per meters squared	kg/m ²
pascals	Pa
megapascals	MPa
dynes per centimeter squared	dyn/cm ²
percent full scale	% FS
User 1	User 1
User 2	User 2

11.2 Conversion Factors, bar

The following table lists factors which should be used as multipliers when converting other pressure units to or from bar.

Table 11.2 - Conversion Factors, bar

ID	Name	Unit	p [bar] / p [Unit]	p [Unit] / p [bar]
0	bar	bar	1.000000E+00	1.000000E+00
1	Millibar	mbar	1.000000E-03	1.000000E+03
2	Pascal	Pa	1.000000E-05	1.000000E+05
3	pound-force / inch ²	psi	6.894757E-02	1.450377E+01
4	standard atmosphere (760 Torr)	atm	1.013250E+00	9.869233E-01
5	Technical atmosphere	kp/cm2	9.806650E-01	1.019716E+00
6	pound-force / foot ²	lbf/ft2	4.788026E-04	2.088543E+03
7	kilopascal	kPa	1.000000E-02	1.000000E+02
8	Centimetres water column 4°C	cmH2O (4°C)	9.806380E-04	1.019744E+03
9	Inch water column 4°C	inH2O (4°C)	2.490820E-03	4.014742E+02
10	Inch water column 20°C	inH2O (20°C)	2.486400E-03	4.021879E+02
11	Inch water column 60°F	inH2O (60°F)	2.488400E-03	4.018647E+02
12	Feet water column 4°C	ftH2O (4°C)	2.988980E-02	3.345623E+01
13	Millimeter mercury column 0°C (Torr)	mmHg (0°C)	1.333224E-03	7.500615E+02
14	Centimetres mercury column 4°C	cmHg (4°C)	1.333224E-02	7.500615E+01
15	Inch mercury column 0°C	inHg (0°C)	3.386380E-02	2.953006E+01
16	Inch mercury column 60°F	inHg (60°F)	3.376850E-02	2.961340E+01
17	--			
18	user			
19	user			
20	user			

11.3 Conversion Factors, PSI

The following table lists factors which should be used as multipliers when converting other pressure units to or from psi.

Table 11.3 – Conversion Factors, psi

Pressure unit	To convert from PSI	To convert to PSI
psi	1	1
bar	0.06894757	14.50377
mbar	68.94757	0.01450377
hPa	68.94757	0.01450377
kPa	6.894757	0.1450377
kg/sq cm	0.07030697	14.22334
inHg @0C	2.036020	0.4911544
inH2O @4C	27.68067	0.03612629
inH2O @20C	27.72977	0.03606233
inH2O @60F	27.70759	0.03609119
ftH2O @4C	2.306726	0.4335149
ftH2O @20C	2.310814	0.4327480
ftH2O @60F	2.308966	0.4330943
mmHg @0C	51.71508	0.01933672
mmH2O @4C	703.0890	0.001422295
mmH2O @20C	704.336	0.001419777
cmHg @0C	5.171508	0.1933672
cmH2O @4C	70.30890	0.01422295
cmH2O @20C	70.4336	0.01419777
oz/si	16	0.0625
psf	144	0.006944444
tons/sq in	0.0005	2000
tons/sq ft	0.072	13.88889
inSW	26.92334	0.03714250
ftSW	2.243611	0.445710
inHg @60F	2.041772	0.4897707
Torr	51.71508	0.01933672
mTorr	51715.08	0.00001933672
micronHg @0C	51715.08	0.00001933672
mmHg @0C	51.71508	0.01933672
cmHg @0C	5.171508	0.1933672
mHg 0C		
mH2O @20C	0.704336	1.419777
mH2O @4C	0.7030890	1.422295
mSW	0.6838528	1.462303

High-End Pressure Controller CPC8000

g/cm ²	70.30697	0.01422334
kg/m ²		
Pa	6894.757	0.0001450377
MPa	0.006894757	145.0377
dyn/cm ²	68947.57	0.00001450377
% FS	(PSI / RANGE) x 100	(% FS x RANGE) / 100
USER 1		
USER 2		

11.4 Conversion Factors, millitorr

The following table lists factors which should be used as multipliers when converting other pressure units to or from millitorr.

Table 11.4 – Conversion Factors, millitorr

Code	Pressure unit	To convert from millitorr	To convert to millitorr
1	psi	0.00001933672	51715.08
2	inHg @0C	0.00003936995	25400.08909
3	inHg @60F	0.00003948117	25328.53093
4	inH2O @4C	0.0005352534	1868.273977
5	inH2O @20C	0.0005362028	1864.966281
6	inH2O @60F	0.0005357739	1866.458778
7	ftH2O @4C	0.00004460451	22419.25773
8	ftH2O @20C	0.00004468356	22379.59744
9	ftH2O @60F	0.00004464783	22397.50637
10	mTorr	1.0	1.000000000
11	inSW @0C 3.5% salinity	0.0005206091	1920.827359
12	ftSW @0C 3.5% salinity	0.00004338408	23049.92831
13	atm	0.000001315786	760002.2299
14	bar	0.000001333220	750063.6259
15	mbar	0.001333220	750.0636259
16	mmH2O @4C	0.0135954	73.5540997
17	cmH2O @4C	0.001359544	735.5409971
18	mH2O @4C	0.00001359544	73554.09971
19	mmHg @0C	0.001	1000.000000
20	cmHg @0C	0.0001	10000.00000
21	Torr	0.001	1000.000000
22	kPa	0.0001333220	7500.636259
23	Pa	0.1333220	7.500636259
24	dyn/sq cm	1.333220	0.750063626
25	g/sq cm	0.001359506	735.561166
26	kg/sq cm	0.000001359506	735561.166

High-End Pressure Controller CPC8000

27	mSW @0C 3.5% salinity	0.00001322347	75623.11663
28	oz/si	0.0003093875	3232.1992
29	psf	0.002784488	359.132477
30	tons/sq ft	0.000001392244	718265.0575
32	micronHg @0C	1.0	1.000000000
33	tons/sq in	0.00000000966836	103430160.00
35	hPa	0.001333220	750.0636259
36	MPa	0.0000001333220	7500636.259
37	mmH2O @20C	0.01361955	73.42388114
38	cmH2O @20C	0.001361955	734.2388114
39	mH2O @20C	0.00001361955	73423.88114



Mensor

201 Barnes Drive
San Marcos, Texas 78666
Tel. 512-396-4200



Fax 512-396-1820
sales@mensor.com
www.@mensor.com

High-End Pressure Controller CPC8000

PN 0018508001AM • 10/2018



WIKAI Alexander Wiegand SE & Co. KG

Alexander-Wiegand-Straße 30
63911 Klingenberg / Germany
Tel. +49 9372 132-5015
Fax +49 9372 132-8767
CTSales@wika.de
www.wika.de